

# **Hydraulic Hose, Fittings and Accessories**



**Stirling Hydraulic**



# TABLE OF CONTENTS

<b>Hydraulic Hose</b>	Single Wire Braid _____	3
	Double Wire Braid _____	3-4
	Four Spiral _____	5
	Six Spiral _____	6
	Jack Hose _____	6
	Truck Hose _____	7
	Suction & Push-On _____	8
	Thermoplastic _____	9-10
	BOP Hose _____	11
	Oilfield 2" Kelly _____	11
	Grease Hose _____	11
	Pressure Washer _____	12
	Teflon _____	12
	<b>Crimp Fittings</b>	Crimp Fitting Compatability Chart _____
Pipe Thread _____		14
JIC 37° Flare _____		15-16
SAE Flareless _____		16
SAE 45° _____		16
O-Ring Boss _____		16
O-Ring Face Seal _____		16-17
Inverted Flare _____		17-18
C61 Flange _____		18
C62 Flange _____		19
Cat Flange _____		19
Komatsu _____		20
BSP _____		20-21
Metric _____		21-23
<b>Reusable Hose Fittings</b>	Steel _____	24
	Brass _____	25
<b>Adapters</b>	Thread Chart _____	26
	Pipe Thread _____	27-36
	JIC 37° Flare _____	37-53
	O-Ring Boss _____	54-62
	O-Ring Face Seal _____	63-71
	BSP _____	72-74
<b>Live Swivel Joints</b>	Metric _____	75-76
	Straight Swivel Joints _____	77
	90° Swivel Joints _____	77-78
<b>SAE Flange</b>	Steel Flange C61 _____	79
	Steel Flange C62 _____	80
	Black Pipe Flange C61 _____	81
<b>O-Rings</b>	O-Rings _____	81

# THREAD DIMENSIONS

## PIPE THREAD

Dash Size	Pipe Size	Pitch (Threads/Inch)	Male Thread O.D.	Female Thread O.D.
02	1/8	27	0.41	0.37
04	1/4	18	0.54	0.49
06	3/8	18	0.68	0.62
08	1/2	14	0.84	0.76
12	3/4	14	1.06	0.98
16	1	11-1/2	1.31	1.24
20	1-1/4	11-1/2	1.66	1.58
24	1-1/2	11-1/2	1.90	1.82
32	2	11-1/2	2.38	2.28

## O-RING FACE SEAL

Dash Size	Male Thread O.D.	Pitch (Threads/Inch)
04	9/16"	18
06	11/16"	16
08	13/16"	16
10	1"	14
12	1-3/16"	12
16	1-7/16"	12
20	1-11/16"	12
24	2"	12

## JIC THREAD

Dash Size	Male Thread O.D.	Pitch (Threads/Inch)
02	5/16"	24
03	3/8"	24
04	7/16"	20
05	1/2"	20
06	9/16"	18
08	3/4"	16
10	7/8"	14
12	1-1/16"	12
14	1-3/16"	12
16	1-5/16"	12
20	1-5/8"	12
24	1-7/8"	12
32	2-1/2"	12

## ORB THREAD

Dash Size	Male Thread O.D.	Pitch (Threads/Inch)
02	5/16"	24
03	3/8"	24
04	7/16"	20
05	1/2"	20
06	9/16"	18
08	3/4"	16
10	7/8"	14
12	1-1/16"	12
14	1-3/16"	12
16	1-5/16"	12
20	1-5/8"	12
24	1-7/8"	12
32	2-1/2"	12

## INVERTED FLARE

Dash Size	Male Thread O.D.	Pitch (Threads/Inch)
02	5/16"	28
03	3/8"	24
04	7/16"	24
05	1/2"	20
06	5/8"	18
07	11/16"	18
08	3/4"	18
10	7/8"	18
12	1-1/16"	16

## SAE 45° THREAD

Dash Size	Male Thread O.D.	Pitch (Threads/Inch)
02	5/16"	24
03	3/8"	24
04	7/16"	20
05	1/2"	20
06	5/8"	18
08	3/4"	16
10	7/8"	14
12	1-1/16"	14
14	1-1/4"	12
16	1-3/8"	12

## METRIC THREAD LIGHT

DASH SIZE	TUBE O.D.	METRIC THREAD
06	06 mm	12 mm x 1.5
08	08 mm	14 mm x 1.5
10	10 mm	16 mm x 1.5
12	12 mm	18 mm x 1.5
15	15 mm	22 mm x 1.5
18	18 mm	26 mm x 1.5
22	22 mm	30 mm x 2.0
28	28 mm	36 mm x 2.0
35	35 mm	45 mm x 2.0
42	42 mm	52 mm x 2.0

## METRIC THREAD HEAVY

DASH SIZE	TUBE O.D.	METRIC THREAD
06	06 mm	14 mm x 1.5
08	08 mm	16 mm x 1.5
10	10 mm	18 mm x 1.5
12	12 mm	20 mm x 1.5
14	14 mm	22 mm x 1.5
16	16 mm	24 mm x 1.5
20	20 mm	30 mm x 2.0
25	25 mm	36 mm x 2.0
30	30 mm	42 mm x 2.0
38	38 mm	52 mm x 2.0

## BSPB THREAD

Dash Size	Pipe Size	Threads per inch	Pitch in.	Pitch mm	Outer Dia. in.	Outer Dia. mm
02	1/8	28	0.0357	0.907	0.3830	9.728
04	1/4	19	0.0526	1.337	0.5180	13.157
06	3/8	19	0.0526	1.337	0.6560	16.662
08	1/2	14	0.0714	1.814	0.8250	20.955
10	5/8	14	0.0714	1.814	0.9020	22.911
12	3/4	14	0.0714	1.814	1.0410	26.441
16	1	11	0.0909	2.309	1.3090	33.249
20	1-1/4	11	0.0909	2.309	1.6500	41.910
24	1-1/2	11	0.0909	2.309	1.8820	47.803
32	2	11	0.0909	2.309	2.3470	59.614

# CRIMP FITTING COMPATABILITY

		HOSE PART NUMBER	WORKING PRESSURE	FITTING SERIES	
S311	ONE WIRE BRAID SAE 100R1AT EN 853 1SN	S311-04	3263	K....SERIES	NO SKIVE
		S311-06	2610		
		S311-08	2320		
		S311-10	1885		
		S311-12	1523		
		S311-16	1276		
		S311-20	914		
		S311-24	725		
		S311-32	580	J....SERIES	NO SKIVE
S421	TWO WIRE BRAID SAE 100R2AT EN 853 2SN	S421-04	5800	K....SERIES	NO SKIVE
		S421-06	4785		
		S421-08	3988		
		S421-10	3625		
		S421-12	3118		
		S421-16	2393		
		S421-20	1813		
		S421-24	1305		
		S421-32	1131	J....SERIES	NO SKIVE
S470	CONSTANT PRESSURE SAE 100R17	S470-04	3045	K....SERIES	NO SKIVE
		S470-06	3045		
		S470-08	3045		
		S470-10	3045		
		S470-12	3045		
		S470-16	3045		
S490	ULTIMATE TWO WIRE	S490-04	6500	K....SERIES	NO SKIVE
		S490-06	5600		
		S490-08	5000		
		S490-10	4205		
		S490-12	4000		
		S490-16	3000		
S900	FOUR SPIRAL SAE 100R12	S900-06	4000	J.... SERIES OR	NO SKIVE
		S900-08	4000		
		S900-10	4000		
		S900-12	4000		
		S900-16	4000	X....SERIES	SKIVE
		S900-20	3000		
		S900-24	2500		
		S900-32	2500		
S920	FOUR SPIRAL EN 856 4SP/4SH	S920-12	6090	X....SERIES OR	SKIVE
		S920-16	5510		
		S920-20	5075	H....SERIES	NO SKIVE
		S920-24	4205		
		S920-32	3625		
S970	FOUR/SIX SPIRAL SAE 100R13	S970-12	5000	X....SERIES OR	SKIVE
		S970-16	5000		
		S970-20	5000	H....SERIES	NO SKIVE
		S970-24	5000		
		S970-32	5000		
S990	FOUR/SIX SPIRAL SAE 100R15	S990-12	6090	X....SERIES OR	SKIVE
		S990-16	6090		
		S990-20	6090	H....SERIES	NO SKIVE
		S990-24	6090		
		S990-32	6090		

# CRIMP FITTINGS

K - 1 & 2 WIREHOSE  
 J - 4 SPIRAL HOSE - NOSKIVE  
 X - 4 & 6 SPIRAL HOSE - SKIVE  
 H - 4 & 6 SPIRAL HOSE - NO SKIVE

(1)	(2)
HOSE I.D.	NPTF THREAD
04 - 1/4"	02 - 1/8" - 27
05 - 5/16"	04 - 1/4" - 18
06 - 3/8"	06 - 3/8" - 18
08 - 1/2"	08 - 1/2" - 14
10 - 5/8"	12 - 3/4" - 14
12 - 3/4"	16 - 1" - 11-1/2
16 - 1"	20 - 1-1/4" - 11-1/2
20 - 1-1/4"	24 - 1-1/2" - 11-1/2
24 - 1-1/2"	32 - 2" - 11-1/2
32 - 2"	

## NPT MALE SWIVEL

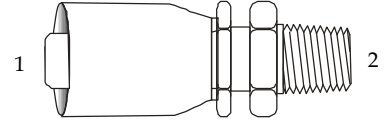

- (1) (2)  
 K04-02MPX  
 K04-04MPX  
 K04-06MPX  
 K06-04MPX  
 K06-06MPX  
 K06-08MPX  
 K08-06MPX  
 K08-08MPX  
 K10-12MPX  
 K12-08MPX  
 K12-12MPX  
 K16-16MPX

## NPT MALE

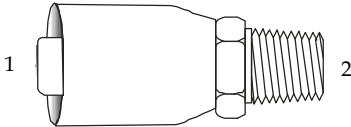

(1) (2)	(1) (2)	(1) (2)	(1) (2)
K04-02MP	J06-04MP	X12-12MP	H20-20MP
K04-04MP	J06-06MP	X16-16MP	H24-24MP
K04-06MP	J06-08MP	X20-20MP	H32-32MP
K04-08MP	J08-06MP	X24-24MP	
K06-04MP	J08-08MP	X32-32MP	
K06-06MP	J08-12MP		
K06-08MP	J10-08MP		
K08-04MP	J10-12MP		
K08-06MP	J12-12MP		
K08-08MP	J12-16MP		
K08-12MP	J16-12MP		
K10-08MP	J16-16MP		
K10-12MP	J16-20MP		
K12-08MP	J20-20MP		
K12-12MP	J20-24MP		
K12-16MP	J24-24MP		
K16-12MP	J32-32MP		
K16-16MP			
K16-20MP			

## NPSM FEMALE SWIVEL

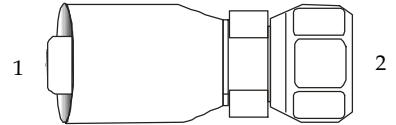

- (1) (2)  
 K04-04FPX  
 K06-06FPX  
 K06-08FPX  
 K08-08FPX  
 K08-12FPX  
 K12-12FPX  
 K16-16FPX

## NPSM FEMALE RIGID

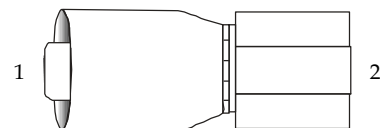

- (1) (2)  
 K04-02FP  
 K04-04FP  
 K04-06FP  
 K06-04FP  
 K06-06FP  
 K06-08FP  
 K08-06FP  
 K08-08FP  
 K12-12FP

# CRIMP FITTINGS

## JIC 37° FEMALE SWIVEL

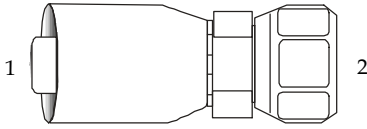

(1) (2)	(1) (2)	(1) (2)	(1) (2)
K04-04FJ	J06-04FJ	X12-12FJ	H20-20FJ
K04-05FJ	J06-06FJ	X16-16FJ	H20-24FJ
K04-06FJ	J06-08FJ	X16-20FJ	H24-24FJ
K06-04FJ	J06-10FJ	X20-20FJ	H32-32FJ
K06-05FJ	J08-06FJ	X20-24FJ	
K06-06FJ	J08-08FJ	X24-24FJ	
K06-08FJ	J08-10FJ	X32-32FJ	
K06-10FJ	J08-12FJ		
K08-06FJ	J10-08FJ		
K08-08FJ	J10-10FJ		
K08-10FJ	J10-12FJ	(1)	(2)
K08-12FJ	J12-10FJ	HOSE I.D.	JIC THREADS
K10-08FJ	J12-12FJ	04 - 1/4"	02 - 5/16 - 24
K10-10FJ	J12-14FJ	05 - 5/16"	03 - 3/8 - 24
K10-12FJ	J12-16FJ	06 - 3/8"	04 - 7/16 - 20
K12-10FJ	J16-12FJ	08 - 1/2"	05 - 1/2 - 20
K12-12FJ	J16-16FJ	10 - 5/8"	06 - 9/16 - 18
K12-14FJ	J16-20FJ	12 - 3/4"	08 - 3/4 - 16
K12-16FJ	J20-16FJ	16 - 1"	10 - 7/8 - 14
K16-12FJ	J20-20FJ	20 - 1-1/4"	12 - 1-1/16 - 12
K16-16FJ	J20-24FJ	24 - 1-1/2"	14 - 1-3/16 - 12
K16-20FJ	J24-24FJ	32 - 2"	16 - 1-5/16 - 12
	J32-32FJ		20 - 1-5/8 - 12
			24 - 1-7/8 - 12
			32 - 2-1/2 - 12

## JIC 37° FEMALE 90° ELBOW

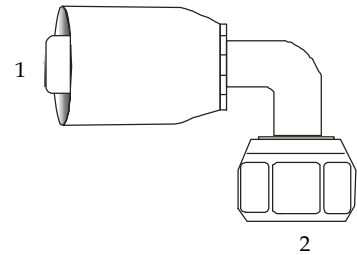

(1) (2)	(1) (2)	(1) (2)	(1) (2)
K04-04FJ90	J06-06FJ90	X12-12FJ90	H20-20FJ90
K04-05FJ90	J06-08FJ90	X16-16FJ90	H24-24FJ90
K04-06FJ90	J06-10FJ90	X20-20FJ90	H32-32FJ90
K06-06FJ90	J08-08FJ90	X24-24FJ90	
K06-08FJ90	J08-10FJ90	X32-32FJ90	
K06-10FJ90	J08-12FJ90		
K08-06FJ90	J10-10FJ90		
K08-08FJ90	J10-12FJ90		
K08-10FJ90	J12-10FJ90		
K08-12FJ90	J12-12FJ90		
K10-10FJ90	J12-16FJ90		
K10-12FJ90	J16-16FJ90		
K12-10FJ90	J16-20FJ90		
K12-12FJ90	J20-20FJ90		
K12-16FJ90	J20-24FJ90		
K16-16FJ90	J24-24FJ90		
K16-20FJ90	J32-32FJ90		

## JIC 37° FEMALE 45° ELBOW

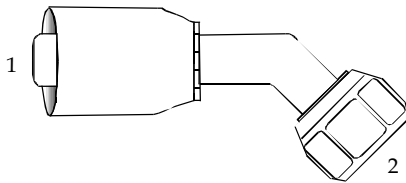

(1) (2)	(1) (2)	(1) (2)	(1) (2)
K04-04FJ45	J06-04FJ45	X12-12FJ45	H20-20FJ45
K04-05FJ45	J06-06FJ45	X16-16FJ45	H24-24FJ45
K04-06FJ45	J06-08FJ45	X20-20FJ45	H32-32FJ45
K06-04FJ45	J06-10FJ45	X24-24FJ45	
K06-06FJ45	J08-08FJ45	X32-32FJ45	
K06-08FJ45	J08-10FJ45		
K06-10FJ45	J10-10FJ45		
K08-08FJ45	J10-12FJ45		
K08-10FJ45	J12-12FJ45		
K10-10FJ45	J12-16FJ45		
K10-12FJ45	J16-16FJ45		
K12-12FJ45	J16-20FJ45		
K12-16FJ45	J20-20FJ45		
K16-16FJ45	J24-24FJ45		
	J32-32FJ45		

## JIC 37° FEMALE 90° ELBOW LONG

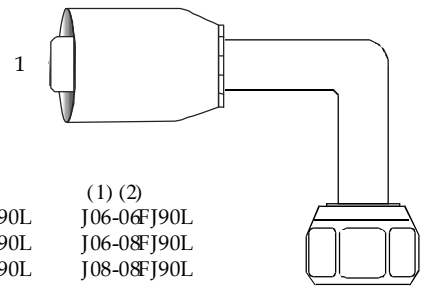

(1) (2)	(1) (2)
K04-04FJ90L	J06-06FJ90L
K04-05FJ90L	J06-08FJ90L
K04-06FJ90L	J08-08FJ90L
K05-06FJ90L	J08-10FJ90L
K06-06FJ90L	J10-10FJ90L
K06-08FJ90L	J10-12FJ90L
K08-08FJ90L	J12-12FJ90L
K08-10FJ90L	J16-16FJ90L
K10-10FJ90L	J16-20FJ90L
K10-12FJ90L	J20-20FJ90L
K12-12FJ90L	
K12-16FJ90L	
K16-16FJ90L	

K - 1 & 2 WIRE HOSE  
 J - 4 SPIRAL HOSE - NO SKIVE  
 X - 4 & 6 SPIRAL HOSE - SKIVE  
 H - 4 & 6 SPIRAL HOSE - NO SKIVE

# CRIMP FITTINGS

## JIC MALE

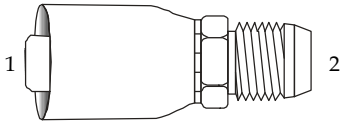

(1) (2)	(1) (2)	(1) (2)	(1) (2)
K04-04MJ	J06-06MJ	H20-20MJ	X12-12MJ
K04-05MJ	J06-08MJ	H24-24MJ	X16-16MJ
K04-06MJ	J06-10MJ	H32-32MJ	X20-20MJ
K06-06MJ	J08-08MJ		X24-24MJ
K06-08MJ	J08-10MJ		X32-32MJ
K06-10MJ	J08-12MJ		
K08-06MJ	J10-08MJ		
K08-08MJ	J10-10MJ		
K08-10MJ	J10-12MJ		
K08-12MJ	J12-10MJ		
K10-08MJ	J12-12MJ		
K10-10MJ	J12-14MJ		
K10-12MJ	J12-16MJ		
K12-10MJ	J16-16MJ		
K12-12MJ	J16-20MJ		
K12-14MJ	J20-20MJ		
K12-16MJ	J24-24MJ		
K16-16MJ	J32-32MJ		
K16-20MJ			

## O-RING BOSS MALE

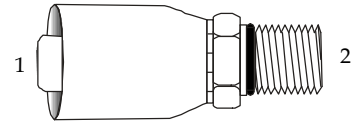

(1) (2)	(1) (2)
K04-04MOB	J06-06MOB
K04-05MOB	J06-08MOB
K04-06MOB	J08-08MOB
K06-06MOB	J10-10MOB
K06-08MOB	J10-12MOB
K06-10MOB	J12-12MOB
K08-08MOB	J16-16MOB
K08-10MOB	
K08-12MOB	
K10-10MOB	
K10-12MOB	
K12-12MOB	
K12-14MOB	
K12-16MOB	
K16-16MOB	

## SAE FLARELESS COMPRESSION

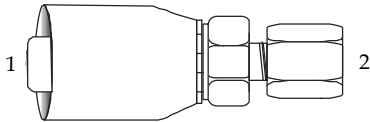

(1) (2)
K04-04MRNS
K06-05MRNS
K06-06MRNS
K08-08MRNS
K08-10MRNS
K12-12MRNS

## O-RING BOSS MALE SWIVEL

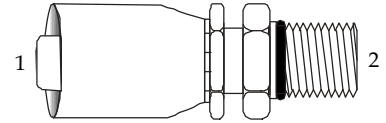

(1) (2)
K04-04MOBX
K06-06MOBX
K06-08MOBX
K08-08MOBX
K08-10MOBX
K12-12MOBX

## SAE 45° FEMALE SWIVEL

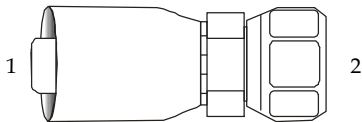

(1) (2)	
K04-06FA	
K06-06FA	
K06-08FA	
K08-08FA	K - 1 & 2 WIRE HOSE
K08-10FA	J - 4 SPIRAL HOSE - NO SKIVE
K10-12FA	X - 4 & 6 SPIRAL HOSE - SKIVE
K12-12FA	H - 4 & 6 SPIRAL HOSE - NO SKIVE

## ORFS FEMALE SWIVEL

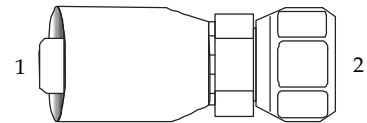

(1) (2)	(1) (2)	(1) (2)	(1) (2)
K04-04FF	J06-06FF	X12-12FF	H20-20FF
K04-06FF	J06-08FF	X16-16FF	H24-24FF
K06-04FF	J08-06FF	X20-20FF	
K06-06FF	J08-08FF	X24-24FF	
K06-08FF	J08-10FF		
K08-06FF	J08-12FF		
K08-08FF	J10-10FF		
K08-10FF	J10-12FF		
K08-12FF	J12-10FF		
K10-10FF	J12-12FF		
K10-12FF	J12-16FF		
K12-10FF	J16-12FF		
K12-12FF	J16-16FF		
K12-16FF	J16-20FF		
K16-16FF	J20-20FF		
	J20-24FF		
	J24-24FF		



# CRIMP FITTINGS

## ORFS FEMALE 45° ELBOW

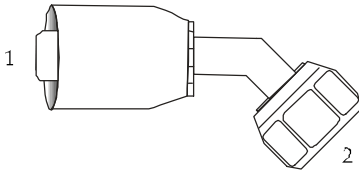

(1) (2)	(1) (2)	(1) (2)	(1) (2)
K04-04FF45	J06-06FF45	X12-12FF45	H20-20FF45
K04-06FF45	J06-08FF45	X16-16FF45	H24-24FF45
K06-06FF45	J08-08FF45	X20-20FF45	
K06-08FF45	J08-10FF45	X24-24FF45	
K08-06FF45	J08-12FF45		
K08-08FF45	J10-10FF45		
K08-10FF45	J10-12FF45		
K10-10FF45	J12-12FF45		
K10-12FF45	J16-16FF45		
K12-12FF45	J20-20FF45		
K12-16FF45	J24-24FF45		
K16-16FF45			

## ORFS FEMALE 90° ELBOW LONG

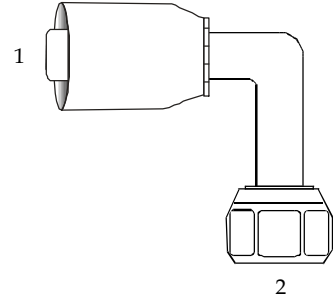

(1) (2)	(1) (2)
K04-04FF90L	J08-08FF90L
K04-06FF90L	J08-10FF90L
K06-06FF90L	J12-12FF90L
K06-08FF90L	J12-16FF90L
K08-08FF90L	J16-16FF90L
K08-10FF90L	J20-20FF90L
K10-10FF90L	
K12-12FF90L	
K16-16FF90L	

## ORFS FEMALE SWIVEL - 90° ELBOW

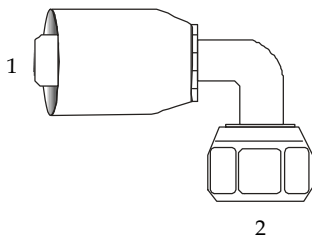

(1) (2)	(1) (2)	(1) (2)	(1) (2)
K04-04FF90	J06-06FF90	X12-12FF90	H20-20FF90
K04-06FF90	J06-08FF90	X16-16FF90	H24-24FF90
K06-04FF90	J08-08FF90	X20-20FF90	
K06-06FF90	J08-10FF90	X24-24FF90	
K06-08FF90	J08-12FF90		
K08-06FF90	J10-10FF90		
K08-08FF90	J10-12FF90		
K08-10FF90	J12-10FF90		
K08-12FF90	J12-12FF90		
K10-10FF90	J12-16FF90		
K10-12FF90	J16-16FF90		
K12-10FF90	J16-20FF90		
K12-12FF90	J20-20FF90		
K12-16FF90	J24-24FF90		
K16-16FF90			

## ORFS MALE

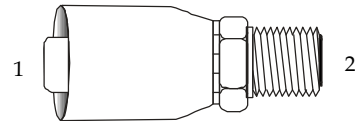

(1)(2)
K04-04MF
K04-06MF
K06-06MF
K06-08MF
K08-08MF
K08-10MF
K08-12MF
K10-10MF
K10-12MF
K12-12MF
K12-16MF
K16-16MF

## MALE INVERTED FLARE

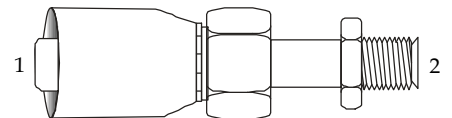

(1) (2)
K04-04MIX
K04-05MIX
K06-05MIX
K06-06MIX
K08-08MIX

K - ONE & TWOWIRE HOSE  
 J - 4 SPIRAL HOSE - NOSKIVE  
 X - 4 & 6 SPIRAL HOSE -SKIVE  
 H - 4 & 6 SPIRALHOSE - NO SKIVE

# CRIMP FITTINGS

## MALE INVERTED FLARE - 45° ELBOW

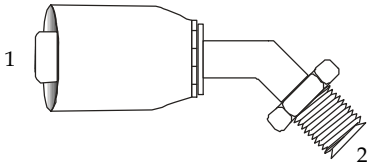

- (1) (2)  
 K04-04MIX45  
 K04-05MIX45  
 K06-05MIX45  
 K06-06MIX45  
 K08-08MIX45

## SAE CODE 61 FLANGE - 45° ELBOW

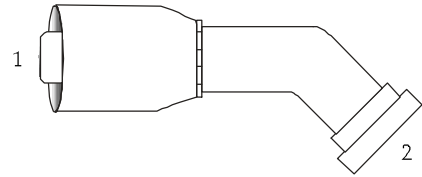

- |            |            |            |
|------------|------------|------------|
| (1) (2)    | (1) (2)    | (1) (2)    |
| K08-08FL45 | J08-08FL45 | X12-12FL45 |
| K08-12FL45 | J08-12FL45 | X12-16FL45 |
| K10-12FL45 | J10-12FL45 | X16-16FL45 |
| K12-12FL45 | J12-12FL45 | X20-20FL45 |
| K12-16FL45 | J12-16FL45 | X20-24FL45 |
| K16-16FL45 | J16-16FL45 | X24-24FL45 |
| K16-20FL45 | J16-20FL45 | X24-32FL45 |
|            | J20-16FL45 | X32-32FL45 |
|            | J20-20FL45 |            |
|            | J20-24FL45 |            |
|            | J24-24FL45 |            |
|            | J24-32FL45 |            |
|            | J32-24FL45 |            |
|            | J32-32FL45 |            |

## MALE INVERTED FLARE - 90° ELBOW

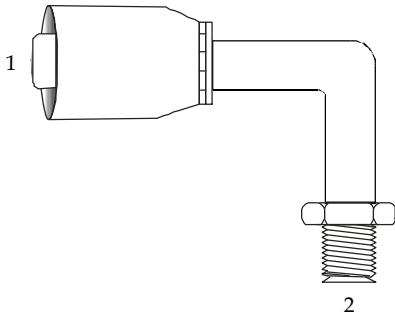

- (1) (2)  
 K04-04MIX90  
 K04-05MIX90  
 K06-05MIX90  
 K06-06MIX90  
 K08-08MIX90

## SAE CODE 61 FLANGE - 90° ELBOW

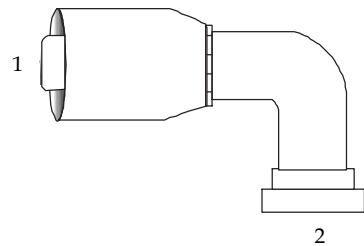

## SAE CODE 61 FLANGE

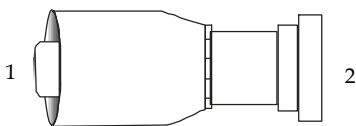

- |          |          |          |
|----------|----------|----------|
| (1) (2)  | (1) (2)  | (1) (2)  |
| K08-08FL | J08-08FL | X12-12FL |
| K08-12FL | J08-12FL | X16-16FL |
| K10-12FL | J10-12FL | X16-20FL |
| K12-12FL | J12-12FL | X20-20FL |
| K12-16FL | J12-16FL | X20-24FL |
| K16-16FL | J12-20FL | X24-24FL |
| K16-20FL | J16-16FL | X24-32FL |
|          | J16-20FL | X32-24FL |
|          | J16-24FL | X32-32FL |
|          | J20-16FL |          |
|          | J20-20FL |          |
|          | J20-24FL |          |
|          | J20-32FL |          |
|          | J24-24FL |          |
|          | J24-32FL |          |
|          | J32-32FL |          |
|          | J32-40FL |          |

- |            |            |            |
|------------|------------|------------|
| (1) (2)    | (1) (2)    | (1) (2)    |
| K08-08FL90 | J08-08FL90 | X12-12FL90 |
| K08-12FL90 | J08-12FL90 | X16-16FL90 |
| K10-12FL90 | J10-12FL90 | X20-20FL90 |
| K12-12FL90 | J12-12FL90 | X20-24FL90 |
| K12-16FL90 | J12-16FL90 | X24-24FL90 |
| K16-16FL90 | J12-20FL90 | X24-32FL90 |
| K16-20FL90 | J16-16FL90 | X32-32FL90 |
|            | J16-20FL90 |            |
|            | J16-24FL90 |            |
|            | J20-16FL90 |            |
|            | J20-20FL90 |            |
|            | J20-24FL90 |            |
|            | J24-24FL90 |            |
|            | J24-32FL90 |            |
|            | J32-24FL90 |            |
|            | J32-32FL90 |            |
|            | J32-40FL90 |            |

K - ONE & TWO WIRE HOSE  
 J - 4 SPIRAL HOSE - NOSKIVE  
 X - 4 & 6 SPIRAL HOSE - SKIVE  
 H - 4 & 6 SPIRAL HOSE - NO SKIVE

# CRIMP FITTINGS

## SAE CODE 62 FLANGE

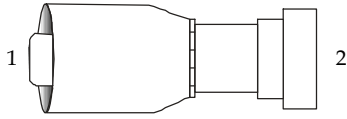

(1) (2)	(1) (2)
J08-08FLH	X12-12FLH
J08-12FLH	X12-16FLH
J10-12FLH	X16-16FLH
J12-12FLH	X16-20FLH
J12-16FLH	X20-20FLH
J16-16FLH	X20-24FLH
J16-20FLH	X24-24FLH
J20-16FLH	X24-20FLH
J20-20FLH	X24-24FLH
J20-24FLH	X24-32FLH
J24-24FLH	X32-32FLH
J24-32FLH	
J32-32FLH	

## CAT STYLE FLANGE

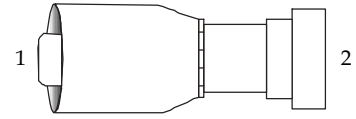

(1) (2)	(1) (2)
AY1CJ-12-12	AY1CX-12-12
AY1CJ-12-16	AY1CX-12-16
AY1CJ-16-16	AY1CX-16-16
AY1CJ-16-20	AY1CX-16-20
AY1CJ-20-20	AY1CX-20-20
AY1CJ-20-24	AY1CX-24-24
AY1CJ-24-24	AY1CX-24-32
AY1CJ-24-32	AY1CX-32-32
AY1CJ-32-32	

## SAE CODE 62 FLANGE - 45° ELBOW

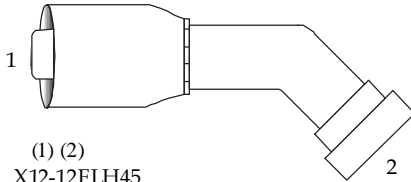

(1) (2)	(1) (2)
J08-08FLH45	X12-12FLH45
J08-12FLH45	X12-16FLH45
J10-12FLH45	X16-16FLH45
J12-12FLH45	X16-20FLH45
J12-16FLH45	X20-16FLH45
J16-12FLH45	X20-20FLH45
J16-16FLH45	X20-24FLH45
J16-20FLH45	X24-24FLH45
J20-16FLH45	X24-32FLH45
J20-20FLH45	X32-32FLH45
J20-24FLH45	
J24-24FLH45	
J24-32FLH45	
J32-32FLH45	

## CAT STYLE FLANGE - 45° ELBOW

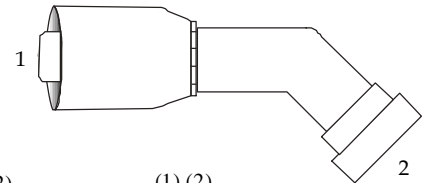

(1) (2)	(1) (2)
AY4CJ-12-12	AY4CX-12-12
AY4CJ-12-16	AY4CX-12-16
AY4CJ-16-16	AY4CX-16-16
AY4CJ-16-20	AY4CX-16-20
AY4CJ-20-16	AY4CX-20-16
AY4CJ-20-20	AY4CX-20-20
AY4CJ-20-24	AY4CX-24-24
AY4CJ-24-24	AY4CX-32-32
AY4CJ-24-32	
AY4CJ-32-32	

## SAE CODE 62 FLANGE - 90° ELBOW

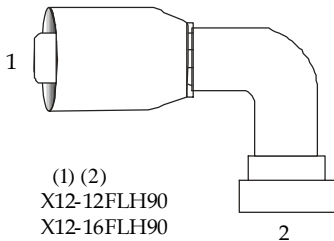

(1) (2)	(1) (2)
J08-08FLH90	X12-12FLH90
J08-12FLH90	X12-16FLH90
J10-12FLH90	X16-16FLH90
J12-12FLH90	X16-20FLH90
J12-16FLH90	X20-16FLH90
J16-16FLH90	X20-20FLH90
J16-20FLH90	X20-24FLH90
J20-16FLH90	X24-24FLH90
J20-20FLH90	X24-32FLH90
J20-24FLH90	X32-32FLH90
J24-24FLH90	
J24-32FLH90	
J32-32FLH90	

## CAT STYLE FLANGE - 90° ELBOW

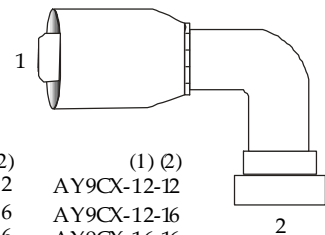

(1) (2)	(1) (2)
AY9CJ-12-12	AY9CX-12-12
AY9CJ-12-16	AY9CX-12-16
AY9CJ-16-16	AY9CX-16-16
AY9CJ-16-20	AY9CX-16-20
AY9CJ-20-20	AY9CX-20-20
AY9CJ-20-24	AY9CX-24-24
AY9CJ-24-24	AY9CX-32-32
AY9CJ-24-32	
AY9CJ-32-32	

K - ONE & TWO WIRE HOSE  
 J - 4 SPIRAL HOSE - NO SKIVE  
 X - 4 & 6 SPIRAL HOSE - SKIVE  
 H - 4 & 6 SPIRAL HOSE - NOSKIVE

# CRIMP FITTINGS

## KOMATSU FLANGE

(1) (2)  
K10-10FLK

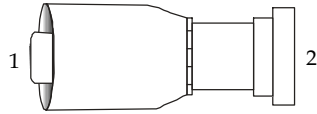

## KOMATSU FLANGE 45° ELBOW

(1) (2)  
K10-10FLK45

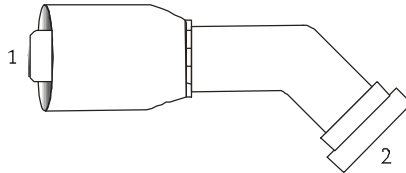

## KOMATSU FLANGE 90° ELBOW

(1) (2)  
K10-10FLK90

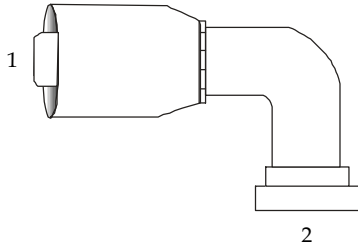

## BSP FEMALE SWIVEL 60° CONE

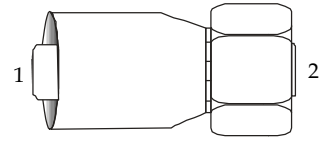

(1) (2)  
K04-02FBSP  
K04-04FBSP  
K04-06FBSP  
K06-04FBSP  
K06-06FBSP  
K06-08FBSP  
K08-06FBSP  
K08-08FBSP  
K08-10FBSP  
K08-12FBSP  
K10-10FBSP  
K10-12FBSP  
K12-12FBSP  
K12-16FBSP  
K16-16FBSP

(1) (2)  
J06-06FBSP  
J06-08FBSP  
J08-08FBSP  
J08-10FBSP  
J10-10FBSP  
J10-12FBSP  
J12-12FBSP  
J12-16FBSP  
J16-16FBSP  
J16-20FBSP  
J20-16FBSP  
J20-20FBSP  
J24-24FBSP  
J32-32FBSP

## BSP BANJO

(1) (2)  
K04-02BJBSP  
K04-04BJBSP  
K04-06BJBSP  
K06-06BJBSP  
K06-08BJBSP  
K08-08BJBSP  
K10-10BJBSP  
K12-12BJBSP  
K16-16BJBSP

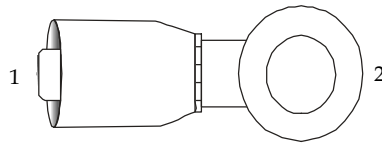

## BSP TAPERED MALE 60° CONE

(1) (2)  
K04-04MBSPT  
K04-06MBSPT  
K06-04MBSPT  
K06-06MBSPT  
K06-08MBSPT  
K08-06MBSPT  
K08-08MBSPT  
K08-12MBSPT  
K10-10MBSPT  
K10-12MBSPT  
K12-12MBSPT  
K16-16MBSPT

(1) (2)  
J06-04MBSPT  
J06-06MBSPT  
J06-08MBSPT  
J08-08MBSPT  
J10-10MBSPT  
J12-12MBSPT  
J12-16MBSPT  
J16-16MBSPT  
J20-16MBSPT  
J20-20MBSPT  
J24-24MBSPT  
J32-32MBSPT

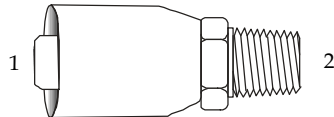

## BSP FEMALE SWIVEL 60° CONE 45° ELBOW

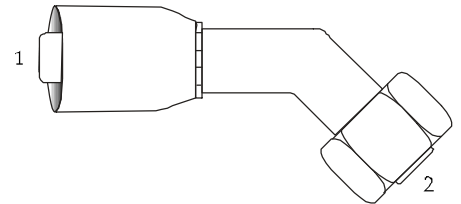

(1) (2)  
K04-04FBSP45  
K04-06FBSP45  
K06-06FBSP45  
K06-08FBSP45  
K08-08FBSP45  
K10-10FBSP45  
K10-12FBSP45  
K16-16FBSP45

(1) (2)  
J06-06FBSP45  
J06-08FBSP45  
J08-08FBSP45  
J10-10FBSP45  
J10-12FBSP45  
J12-12FBSP45  
J16-16FBSP45  
J20-20FBSP45  
J24-24FBSP45  
J32-32FBSP45

K - ONE & TWO WIRE HOSE  
J - 4 SPIRAL HOSE - NO SKIVE  
X - 4 & 6 SPIRAL HOSE - SKIVE  
H - 4 & 6 SPIRAL HOSE - NOSKIVE

# CRIMP FITTINGS

## BSP FEMALE SWIVEL 60° CONE 90° ELBOW

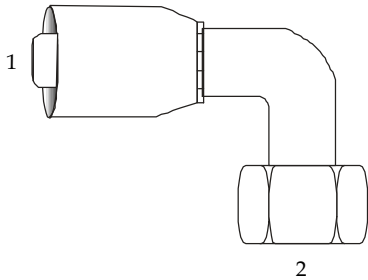

(1) (2)	(1) (2)
K04-04FBSP90	J06-06FBSP90
K04-06FBSP90	J06-08FBSP90
K06-06FBSP90	J08-08FBSP90
K06-08FBSP90	J10-10FBSP90
K08-08FBSP90	J10-12FBSP90
K08-10FBSP90	J12-12FBSP90
K10-10FBSP90	J16-16FBSP90
K10-12FBSP90	J20-20FBSP90
K12-12FBSP90	J24-24FBSP90
K12-16FBSP90	J32-32FBSP90
K16-16FBSP90	

## BSP FLAT FACE FEMALE SWIVEL

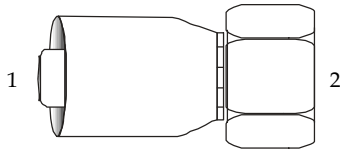

(1) (2)
K06-06FBFFF
K06-08FBFFF
K08-08FBFFF
K08-12FBFFF
K12-12FBFFF

## BSP FLAT FACE MALE

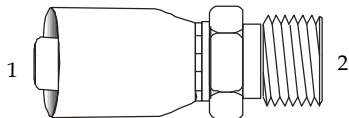

(1) (2)	(1) (2)
K06-06MBSPFF	J06-06MBSPFF
K06-08MBSPFF	J06-08MBSPFF
K08-08MBSPFF	J12-12MBSPFF
K12-16MBSPFF	J16-16MBSPFF
K16-16MBSPFF	

## METRIC STANDPIPE

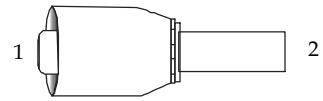

(1) (2)	(1) (2)	(1) (2)
K04-06FBSP90	K08-16FBSP90	K16-28FBSP90
K04-08FBSP90	K10-18FBSP90	K16-30FBSP90
K04-10FBSP90	K10-20FBSP90	
K05-10FBSP90	K12-18FBSP90	
K06-10FBSP90	K12-20FBSP90	
K06-12FBSP90	K12-22FBSP90	
K08-15FBSP90	K12-25FBSP90	

## METRIC STANDPIPE 45° ELBOW

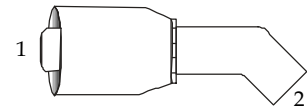

(1) (2)	(1) (2)	(1) (2)
K04-06FBSP90	K08-16FBSP90	K16-28FBSP90
K04-08FBSP90	K10-18FBSP90	K16-30FBSP90
K04-10FBSP90	K10-20FBSP90	
K05-10FBSP90	K12-18FBSP90	
K06-10FBSP90	K12-20FBSP90	
K06-12FBSP90	K12-22FBSP90	
K08-15FBSP90	K12-25FBSP90	

## METRIC STANDPIPE 90° ELBOW

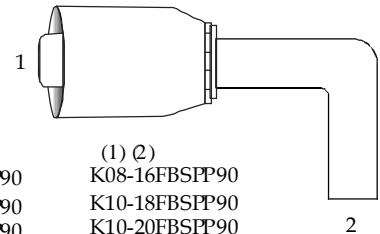

(1) (2)	(1) (2)	(1) (2)
K04-06FBSP90	K08-16FBSP90	K16-28FBSP90
K04-08FBSP90	K10-18FBSP90	K16-30FBSP90
K04-10FBSP90	K10-20FBSP90	
K05-10FBSP90	K12-18FBSP90	
K06-10FBSP90	K12-20FBSP90	
K06-12FBSP90	K12-22FBSP90	
K08-15FBSP90	K12-25FBSP90	

## METRIC BANJO

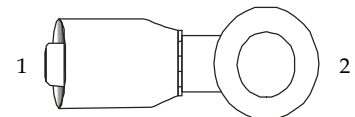

(1) (2)	(1) (2)
K04-12BJM	J06-14BJM
K06-14BJM	J06-16BJM
K06-16BJM	J06-18BJM
K06-18BJM	J06-22BJM
K08-18BJM	J10-22BJM
K08-22BJM	J12-26BJM
K10-22BJM	

# CRIMP FITTINGS

## METRIC LIGHT MALE ( 24° CONE SEAT)

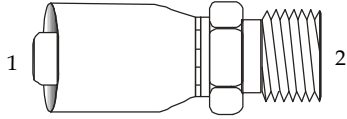

(1) (2)	(1) (2)
K04-12MML	J06-16MML
K04-14MML	J06-18MML
K04-16MML	J06-22MML
K06-16MML	J08-22MML
K06-18MML	J10-26MML
K06-22MML	J12-30MML
K08-18MML	J16-36MML
K08-22MML	J20-45MML
K10-26MML	J24-52MML
K12-30MML	
K16-36MML	

## METRIC LIGHT FEMALE SWIVEL - 45° ELBOW ( 24° CONE SEAT)

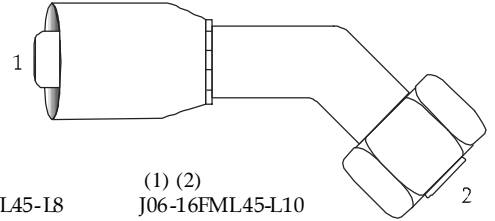

(1) (2)	(1) (2)
K04-14FML45-L8	J06-16FML45-L10
K04-16FML45-L10	J06-18FML45-L12
K04-18FML45-L12	J10-26FML45-L15
K06-16FML45-L10	J12-30FML45-L18
K06-18FML45-L12	J16-36FML45-L28
K08-22FML45-L12	J20-45FML45-L35
K10-26FML45-L15	J24-52FML45-L42
K12-30FML45-L18	

## METRIC LIGHT FEMALE SWIVEL ( 24° CONE SEAT)

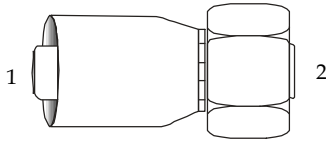

(1) (2)	(1) (2)
K04-12FML-L6	J06-16FML-L10
K04-14FML-L8	J06-18FML-L12
K04-16FML-L10	J06-22FML-L15
K04-18FML-L12	J08-22FML-L15
K06-16FML-L10	J10-26FML-L18
K06-18FML-L12	J12-30FML-L22
K06-22FML-L15	J16-36FML-L28
K08-22FML-L15	J20-45FML-L35
K08-26FML-L18	J24-52FML-L42
K10-26FML-L18	
K12-30FML-L22	
K16-36FML-L28	

## METRIC LIGHT FEMALE SWIVEL - 90° ELBOW ( 24° CONE SEAT)

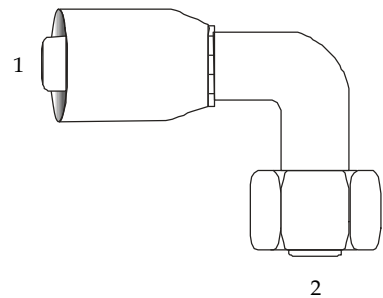

(1) (2)	(1) (2)
K04-14FML90-L8	J06-16FML90-L10
K04-16FML90-L10	J06-18FML90-L12
K06-16FML90-L10	J08-22FML90-L15
K06-18FML90-L12	J10-26FML90-L18
K08-22FML90-L15	J12-30FML90-L22
K08-26FML90-L18	J16-36FML90-L28
K10-26FML90-L18	J20-45FML90-L35
K12-30FML90-L22	J24-52FML90-L42
K16-36FML90-L28	

K - ONE & TWO WIRE HOSE  
 J - 4 SPIRAL HOSE - NO SKIVE  
 X - 4 & 6 SPIRAL HOSE - SKIVE  
 H - 4 & 6 SPIRAL HOSE - NO SKIVE

# CRIMP FITTINGS

## METRIC HEAVY MALE (24° CONE SEAT)

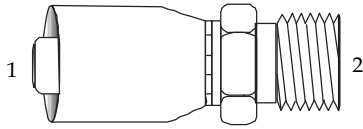

(1) (2)	(1) (2)
K04-14MMS	J06-18MMS
K04-16MMS	J06-20MMS
K04-18MMS	J06-22MMS
K04-20MMS	J06-24MMS
K06-18MMS	J08-24MMS
K06-20MMS	J10-30MMS
K06-22MMS	J12-30MMS
K06-24MMS	J12-36MMS
K08-24MMS	J16-36MMS
K10-30MMS	J16-42MMS
K12-30MMS	J20-52MMS
K12-36MMS	J24-52MMS
K16-36MMS	
K16-42MMS	

## METRIC HEAVY FEMALE SWIVEL 45° ELBOW (24° CONE SEAT)

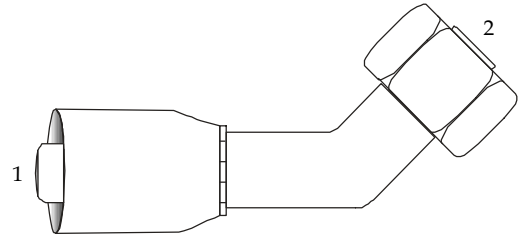

(1) (2)	(1) (2)
K04-14FMS45-S6	J06-20FMS45-S12
K04-16FMS45-S6	J06-22FMS45-S14
K04-18FMS45-S10	J08-24FMS45-S16
K06-20FMS45-S12	J10-30FMS45-S20
K06-22FMS45-S14	J12-36FMS45-S25
K08-24FMS45-S16	J16-42FMS45-S30
K10-30FMS45-S20	J20-52FMS45-S38
K12-30FMS45-S20	J24-52FMS45-S38
K12-36FMS45-S25	
K16-36FMS45-S25	
K16-42FMS45-S30	

## METRIC HEAVY FEMALE SWIVEL (24° CONE SEAT)

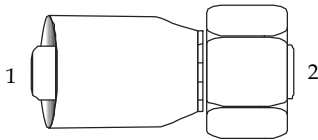

(1) (2)	(1) (2)
K04-14FMS-S6	J06-20FMS-S12
K04-16FMS-S8	J06-22FMS-S14
K04-18FMS-S10	J08-24FMS-S16
K06-18FMS-S10	J10-30FMS-S20
K06-20FMS-S12	J12-30FMS-S20
K06-22FMS-S14	J12-36FMS-S25
K08-24FMS-S16	J16-36FMS-S25
K10-30FMS-S20	J16-42FMS-S30
K12-30FMS-S20	J20-52FMS-S38
K12-36FMS-S25	J24-52FMS-S38
K16-36FMS-S25	
K16-42FMS-S30	

## METRIC HEAVY FEMALE SWIVEL 90° ELBOW (24° CONE SEAT)

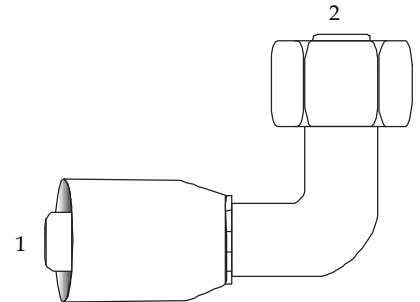

(1) (2)	(1) (2)
K04-14FMS90-S6	J06-20FMS90-S12
K04-16FMS90-S6	J06-22FMS90-S14
K04-18FMS90-S10	J08-24FMS90-S16
K06-18FMS90-S10	J10-30FMS90-S20
K06-20FMS90-S12	J12-30FMS90-S20
K06-22FMS90-S14	J12-36FMS90-S25
K08-24FMS90-S16	J16-36FMS90-S25
K10-30FMS90-S20	J16-42FMS90-S30
K12-30FMS90-S20	J20-52FMS90-S38
K12-36FMS90-S25	J24-52FMS90-S38
K16-36FMS90-S25	
K16-42FMS90-S30	

K - ONE & TWO WIRE HOSE  
 J - 4 SPIRAL HOSE - NO SKIVE  
 X - 4 & 6 SPIRAL HOSE - SKIVE  
 H - 4 & 6 SPIRAL HOSE - NO SKIVE

# REUSABLE COUPLINGS

For use on S200 & S210 100R5 Hose

## NPTF MALE

(1) (2)	(1) (2)
BN04-02MP	BN10-12MP
BN04-04MP	BN12-08MP
BN05-04MP	BN12-12MP
BN06-04MP	BN16-12MP
BN06-06MP	BN16-16MP
BN08-06MP	BN20-20MP
BN08-08MP	BN24-24MP
BN10-08MP	BN32-32MP

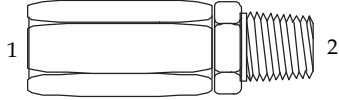

## JIC 37° MALE

(1) (2)
BN04-04MJ
BN05-05MJ
BN06-06MJ
BN08-08MJ
BN10-10MJ
BN12-12MJ
BN16-16MJ

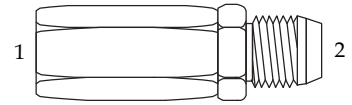

## SAE 45° FEMALE SWIVEL

(1) (2)
BN04-04FA
BN05-05FA
BN06-06FA
BN08-08FA
BN10-10FA
BN12-12FA

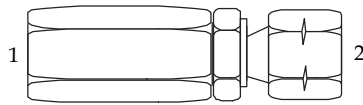

## SAE 45° FEMALE SWIVEL 90° ELBOW

(1) (2)
BN04-04FA90
BN05-05FA90
BN06-06FA90
BN08-08FA90
BN10-10FA90
BN12-12FA90

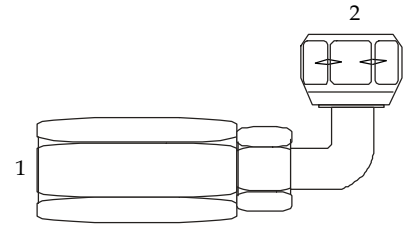

## JIC 37° FEMALE

(1) (2)	(1) (2)
BN04-04FJ	BN10-08FJ
BN05-04FJ	BN10-10FJ
BN05-05FJ	BN12-12FJ
BN05-06FJ	BN16-16FJ
BN06-06FJ	BN20-20FJ
BN08-06FJ	BN24-24FJ
BN08-08FJ	BN32-32FJ

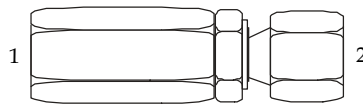

## JIC 37° FEMALE SWIVEL 90° ELBOW

(1) (2)
BN04-04FJ90
BN05-05FJ90
BN06-06FJ90
BN08-08FJ90
BN12-12FJ90
BN16-16FJ90

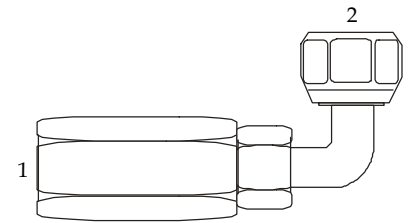

## SAE 45° FEMALE SWIVEL 45° ELBOW

(1) (2)
BN04-04FA45
BN05-05FA45
BN06-06FA45
BN08-08FA45
BN10-10FA45
BN12-12FA45

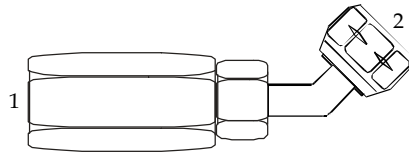

## SAE 45° FEMALE SWIVEL 90° ELBOW LONG

(1) (2)
BN04-04FA90L
BN05-05FA90L
BN06-06FA90L
BN08-08FA90L
BN10-10FA90L
BN12-12FA90L

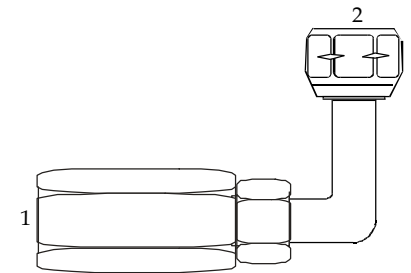

## JIC 37° FEMALE SWIVEL 45° ELBOW

(1) (2)
BN04-04FJ45
BN05-05FJ45
BN06-06FJ45
BN08-08FJ45
BN10-10FJ45
BN12-12FJ45
BN16-16FJ45
BN20-20FJ45

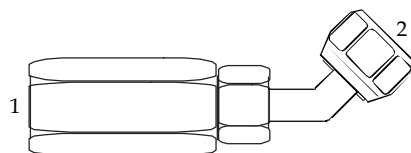

## JIC 37° FEMALE SWIVEL 90° ELBOW LONG

(1) (2)
BN04-04FJ90L
BN05-05FJ90L
BN06-06FJ90L
BN08-08FJ90L
BN10-10FJ90L
BN12-12FJ90L
BN16-16FJ90L
BN20-20FJ90L

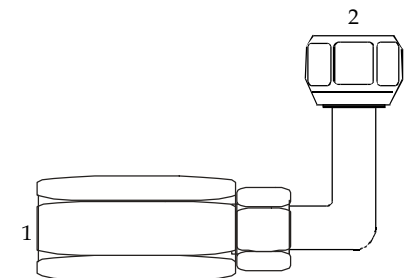

## SAE 45° MALE

(1) (2)
BN04-04MA
BN05-05MA
BN06-06MA
BN08-08MA
BN10-10MA
BN12-12MA

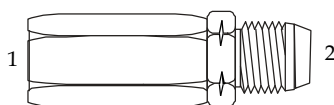



# REUSABLE BRASS FITTINGS

For use on S100 Push-On Hose

## NPTF MALE

	HOSE I.D.	PIPE
725-4A	1/4	1/8
725-4B	1/4	1/4
725-4C	1/4	3/8
725-6A	3/8	1/8
725-6B	3/8	1/4
725-6C	3/8	3/8
725-6D	3/8	1/2
725-8B	1/2	1/4
725-8C	1/2	3/8
725-8D	1/2	1/2
725-8E	1/2	3/4
725-10D	5/8	1/2
725-12D	3/4	1/2
725-12E	3/4	3/4

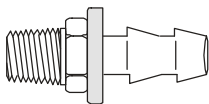

## FEMALE INVERTED FLARE

	HOSE I.D.	TUBE
736-43	1/4	3/16
736-44	1/4	1/4
736-45	1/4	5/16
736-65	3/8	5/16
736-66	3/8	3/8

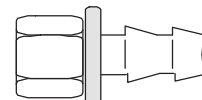

## MALE INVERTED FLARE

	HOSE I.D.	TUBE
735-43	1/4	3/16
735-44	1/4	1/4
735-45	1/4	5/16
735-65	3/8	5/16
735-66	3/8	3/8
735-68	3/8	1/2
735-88	1/2	1/2
735-1010	5/8	5/8

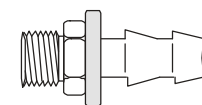

## SAE 45° FEMALE SWIVEL

	HOSE I.D.	TUBE
728-44	1/4	1/4
728-45	1/4	5/16
728-66	3/8	3/8
728-68	3/8	1/2
728-86	1/2	3/8
728-88	1/2	1/2
728-810	1/2	5/8
728-108	5/8	1/2
728-1010	5/8	5/8
728-1212	3/4	3/4

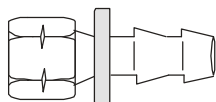

## HOSE SPLICER

	HOSE I.D.
729-4	1/4
729-5	5/16
729-6	3/8
729-8	1/2
729-10	5/8
729-12	3/4

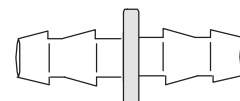

## SAE 45° MALE

	HOSE I.D.	TUBE
727-44	1/4	1/4
727-45	1/4	5/16
727-65	3/8	5/16
727-66	3/8	3/8
727-88	1/2	1/2
727-810	1/2	5/8
727-1010	5/8	5/8

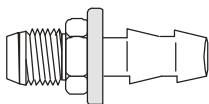

## TUBE END

	HOSE I.D.	TUBE
732-43	1/4	3/16
732-44	1/4	1/4
732-45	1/4	5/16
732-66	3/8	3/8
732-88	1/2	1/2
732-1010	5/8	5/8

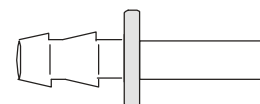

## JIC 37° FEMALE

	HOSE I.D.	TUBE
738-44	1/4	1/4
738-45	1/4	5/16
738-66	3/8	3/8
738-88	1/2	1/2
738-1010	5/8	5/8
738-1212	3/4	3/4

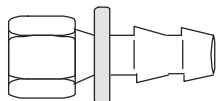

## FEMALE PIPE SWIVEL BALL SEAT

	HOSE I.D.	PIPE
731-4A	1/4	1/8
731-4B	1/4	1/4
731-6B	3/8	1/4
731-6C	3/8	3/8
731-8D	1/2	1/2
731-12E	3/4	3/4

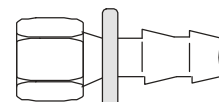

## JIC 37° MALE

	HOSE I.D.	TUBE
737-44	1/4	1/4
737-45	1/4	5/16
737-66	3/8	3/8
737-88	1/2	1/2

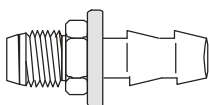

## NPT FEMALE RIGID

	HOSE I.D.	PIPE
726-4A	1/4	1/8
726-4B	1/4	1/4
726-6B	3/8	1/4
726-6C	3/8	3/8
726-8C	1/2	3/8
726-8D	1/2	1/2
726-8E	1/2	3/4
726-12E	3/4	3/4

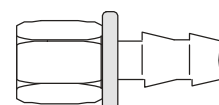

# THREAD DIMENSIONS

## PIPE THREAD

Dash Size	Pipe Size	Pitch (Threads/Inch)	Male Thread O.D.	Female Thread O.D.
02	1/8	27	0.41	0.37
04	1/4	18	0.54	0.49
06	3/8	18	0.68	0.62
08	1/2	14	0.84	0.76
12	3/4	14	1.06	0.98
16	1	11-1/2	1.31	1.24
20	1-1/4	11-1/2	1.66	1.58
24	1-1/2	11-1/2	1.90	1.82
32	2	11-1/2	2.38	2.28

## O-RING FACE SEAL

Dash Size	Male Thread O.D.	Pitch (Threads/Inch)
04	9/16"	18
06	11/16"	16
08	13/16"	16
10	1"	14
12	1-3/16"	12
16	1-7/16"	12
20	1-11/16"	12
24	2"	12

## JIC THREAD

Dash Size	Male Thread O.D.	Pitch (Threads/Inch)
02	5/16"	24
03	3/8"	24
04	7/16"	20
05	1/2"	20
06	9/16"	18
08	3/4"	16
10	7/8"	14
12	1-1/16"	12
14	1-3/16"	12
16	1-5/16"	12
20	1-5/8"	12
24	1-7/8"	12
32	2-1/2"	12

## ORB THREAD

Dash Size	Male Thread O.D.	Pitch (Threads/Inch)
02	5/16"	24
03	3/8"	24
04	7/16"	20
05	1/2"	20
06	9/16"	18
08	3/4"	16
10	7/8"	14
12	1-1/16"	12
14	1-3/16"	12
16	1-5/16"	12
20	1-5/8"	12
24	1-7/8"	12
32	2-1/2"	12

## INVERTED FLARE

Dash Size	Male Thread O.D.	Pitch (Threads/Inch)
02	5/16"	28
03	3/8"	24
04	7/16"	24
05	1/2"	20
06	5/8"	18
07	11/16"	18
08	3/4"	18
10	7/8"	18
12	1-1/16"	16

## SAE 45° THREAD

Dash Size	Male Thread O.D.	Pitch (Threads/Inch)
02	5/16"	24
03	3/8"	24
04	7/16"	20
05	1/2"	20
06	5/8"	18
08	3/4"	16
10	7/8"	14
12	1-1/16"	14
14	1-1/4"	12
16	1-3/8"	12

## METRIC THREAD LIGHT

DASH SIZE	TUBE O.D.	METRIC THREAD
06	06 mm	12 mm x 1.5
08	08 mm	14 mm x 1.5
10	10 mm	16 mm x 1.5
12	12 mm	18 mm x 1.5
15	15 mm	22 mm x 1.5
18	18 mm	26 mm x 1.5
22	22 mm	30 mm x 2.0
28	28 mm	36 mm x 2.0
35	35 mm	45 mm x 2.0
42	42 mm	52 mm x 2.0

## METRIC THREAD HEAVY

DASH SIZE	TUBE O.D.	METRIC THREAD
06	06 mm	14 mm x 1.5
08	08 mm	16 mm x 1.5
10	10 mm	18 mm x 1.5
12	12 mm	20 mm x 1.5
14	14 mm	22 mm x 1.5
16	16 mm	24 mm x 1.5
20	20 mm	30 mm x 2.0
25	25 mm	36 mm x 2.0
30	30 mm	42 mm x 2.0
38	38 mm	52 mm x 2.0

## BSPP THREAD

Dash Size	Pipe Size	Threads per inch	Pitch in.	Pitch mm	Outer Dia. in.	Outer Dia. mm
02	1/8	28	0.0357	0.907	0.3830	9.728
04	1/4	19	0.0526	1.337	0.5180	13.157
06	3/8	19	0.0526	1.337	0.6560	16.662
08	1/2	14	0.0714	1.814	0.8250	20.955
10	5/8	14	0.0714	1.814	0.9020	22.911
12	3/4	14	0.0714	1.814	1.0410	26.441
16	1	11	0.0909	2.309	1.3090	33.249
20	1-1/4	11	0.0909	2.309	1.6500	41.910
24	1-1/2	11	0.0909	2.309	1.8820	47.803
32	2	11	0.0909	2.309	2.3470	59.614

# PIPE THREAD ADAPTERS-QUICK VIEW

Detailed Sizes on the following pages.

**1404**

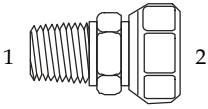

(1) Male Pipe  
(2) Female Pipe

**1405**

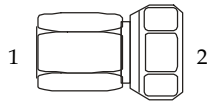

(1) Female Pipe  
(2) Female Pipe

**1501**

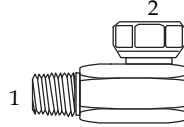

(1) Male Pipe  
(2) Female Pipe

**1501-L**

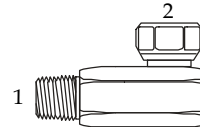

(1) Male Pipe  
(2) Female Pipe

**1502**

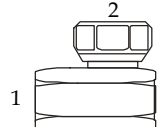

(1) Female Pipe  
(2) Female Pipe

**1503**

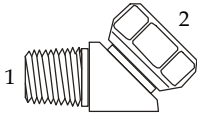

(1) Male Pipe  
(2) Female Pipe

**1504**

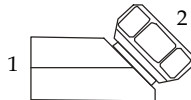

(1) Female Pipe  
(2) Female Pipe

**1601**

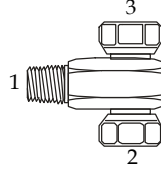

(1) Male Pipe  
(2) (3) Female Pipe

**1602**

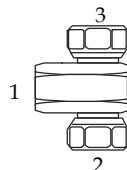

(1) Female Pipe  
(2) (3) Female Pipe

**1603**

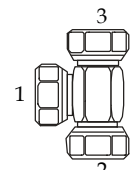

(1) (2) (3) Female Pipe

**5000**

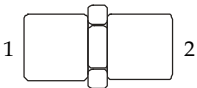

(1) (2) Female Pipe

**5404**

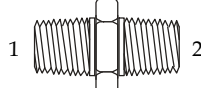

(1) (2) Male Pipe

**5405**

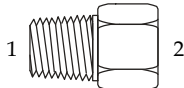

(1) Male Pipe  
(2) Female Pipe

**5406**

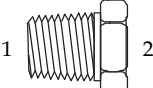

(1) Male Pipe  
(2) Female Pipe

**5406-P**

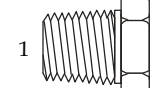

(1) Male Pipe

**5406-HP**

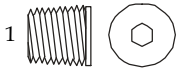

(1) Male Pipe

**5406-SHP**

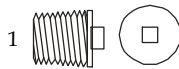

(1) Male Pipe

**5500**

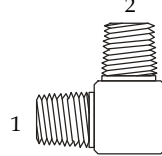

(1) (2) Male Pipe

**5501**

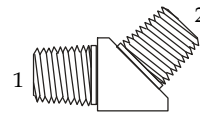

(1) (2) Male Pipe

**5502**

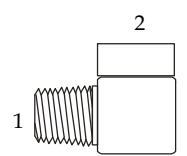

(1) Male Pipe  
(2) Female Pipe

**5503**

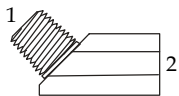

(1) Male Pipe  
(2) Female Pipe

**5504**

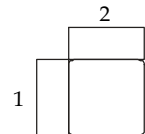

(1) (2) Female Pipe

**5505**

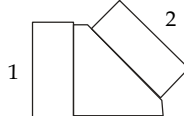

(1) (2) Female Pipe

**5600**

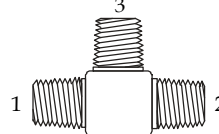

(1) (2) (3) Male Pipe

**5601**

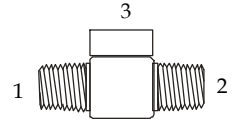

(1) (2) Male Pipe  
(3) Female Pipe

**5602**

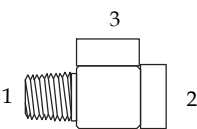

(1) Male Pipe  
(2) (3) Female Pipe

**5603**

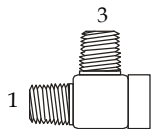

(1) (3) Male Pipe  
(2) Female Pipe

**5604**

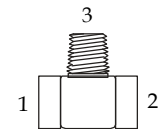

(1) (2) Female Pipe  
(3) Male Pipe

**5605**

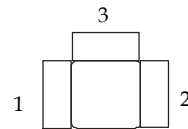

(1) (2) (3) Female Pipe

**5650**

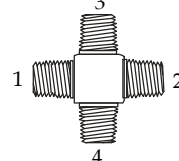

(1) (2) (3) (4) Male Pipe

**5652**

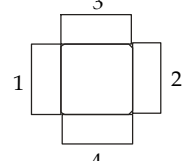

(1) (2) (3) (4) Female Pipe

# PIPE THREAD ADAPTERS

## 1404 ...PIPE SWIVEL UNION

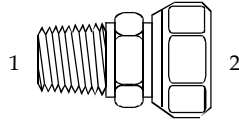

(1) (2)	MALE PIPE	FEMALE PIPE
1404-02-02	1/8" - 27	1/8" - 27
1404-02-04	1/8" - 27	1/4" - 18
1404-04-02	1/4" - 18	1/8" - 27
1404-04-04	1/4" - 18	1/4" - 18
1404-04-06	1/4" - 18	3/8" - 18
1404-04-08	1/4" - 18	1/2" - 14
1404-06-04	3/8" - 18	1/4" - 18
1404-06-06	3/8" - 18	3/8" - 18
1404-06-08	3/8" - 18	1/2" - 14
1404-08-04	1/2" - 14	1/4" - 18
1404-08-06	1/2" - 14	3/8" - 18
1404-08-08	1/2" - 14	1/2" - 14
1404-08-12	1/2" - 14	3/4" - 14
1404-12-06	3/4" - 14	3/8" - 18
1404-12-08	3/4" - 14	1/2" - 14
1404-12-12	3/4" - 14	3/4" - 14
1404-12-16	3/4" - 14	1" - 11-1/2
1404-12-20	3/4" - 14	1-1/4" - 11-1/2
1404-16-06	1" - 11-1/2	3/8" - 18
1404-16-08	1" - 11-1/2	1/2" - 14
1404-16-12	1" - 11-1/2	3/4" - 14
1404-16-16	1" - 11-1/2	1" - 11-1/2
1404-16-20	1" - 11-1/2	1-1/4" - 11-1/2
1404-16-24	1" - 11-1/2	1-1/2" - 11-1/2
1404-20-16	1-1/4" - 11-1/2	1" - 11-1/2
1404-20-20	1-1/4" - 11-1/2	1-1/4" - 11-1/2
1404-20-24	1-1/4" - 11-1/2	1-1/2" - 11-1/2
1404-24-20	1-1/2" - 11-1/2	1-1/4" - 11-1/2
1404-24-24	1-1/2" - 11-1/2	1-1/2" - 11-1/2
1404-24-32	1-1/2" - 11-1/2	2" - 11-1/2
1404-32-32	2" - 11-1/2	2" - 11-1/2

## 1405 ...PIPE SWIVEL UNION

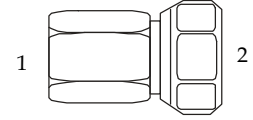

(1) (2)	FEMALE PIPE	FEMALE PIPE
1405-02-02	1/8" - 27	1/8" - 27
1405-02-04	1/8" - 27	1/4" - 18
1405-04-02	1/4" - 18	1/8" - 27
1405-04-04	1/4" - 18	1/4" - 18
1405-04-06	1/4" - 18	3/8" - 18
1405-04-08	1/4" - 18	1/2" - 14
1405-06-04	3/8" - 18	1/4" - 18
1405-06-06	3/8" - 18	3/8" - 18
1405-06-08	3/8" - 18	1/2" - 14
1405-08-04	1/2" - 14	1/4" - 18
1405-08-06	1/2" - 14	3/8" - 18
1405-08-08	1/2" - 14	1/2" - 14
1405-08-12	1/2" - 14	3/4" - 14
1405-12-06	3/4" - 14	3/8" - 18
1405-12-08	3/4" - 14	1/2" - 14
1405-12-12	3/4" - 14	3/4" - 14
1405-12-16	3/4" - 14	1" - 11-1/2
1405-16-12	1" - 11-1/2	3/4" - 14
1405-16-16	1" - 11-1/2	1" - 11-1/2
1405-20-20	1-1/4" - 11-1/2	1-1/4" - 11-1/2
1405-24-24	1-1/2" - 11-1/2	1-1/2" - 11-1/2
1405-32-32	2" - 11-1/2	2" - 11-1/2

### PIPE THREAD

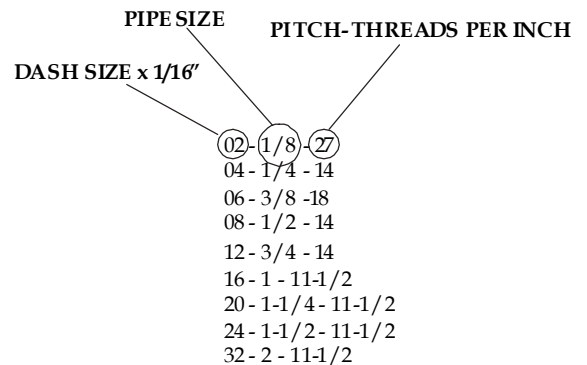

# PIPE THREAD ADAPTERS

## 1501 ...PIPE SWIVEL 90° ELBOW

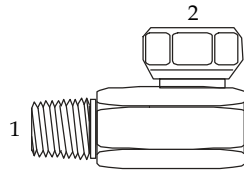

(1) (2)	MALE PIPE	FEMALE PIPE
1501-02-02	1/8" - 27	1/8" - 27
1501-02-04	1/8" - 27	1/4" - 18
1501-04-02	1/4" - 18	1/8" - 27
1501-04-04	1/4" - 18	1/4" - 18
1501-04-06	1/4" - 18	3/8" - 18
1501-04-08	1/4" - 18	1/2" - 14
1501-06-04	3/8" - 18	1/4" - 18
1501-06-06	3/8" - 18	3/8" - 18
1501-06-08	3/8" - 18	1/2" - 14
1501-06-12	3/8" - 18	3/4" - 14
1501-08-04	1/2" - 14	1/4" - 18
1501-08-06	1/2" - 14	3/8" - 18
1501-08-08	1/2" - 14	1/2" - 14
1501-08-12	1/2" - 14	3/4" - 14
1501-12-04	3/4" - 14	1/4" - 18
1501-12-06	3/4" - 14	3/8" - 18
1501-12-08	3/4" - 14	1/2" - 14
1501-12-12	3/4" - 14	3/4" - 14
1501-12-16	3/4" - 14	1" - 11-1/2
1501-12-20	3/4" - 14	1-1/4" - 11-1/2
1501-16-08	1" - 11-1/2	1/2" - 14
1501-16-12	1" - 11-1/2	3/4" - 14
1501-16-16	1" - 11-1/2	1" - 11-1/2
1501-16-20	1" - 11-1/2	1-1/4" - 11-1/2
1501-20-12	1-1/4" - 11-1/2	3/4" - 14
1501-20-16	1-1/4" - 11-1/2	1" - 11-1/2
1501-20-20	1-1/4" - 11-1/2	1-1/4" - 11-1/2
1501-20-24	1-1/4" - 11-1/2	1-1/2" - 11-1/2
1501-24-20	1-1/2" - 11-1/2	1-1/4" - 11-1/2
1501-24-24	1-1/2" - 11-1/2	1-1/2" - 11-1/2
1501-32-32	2" - 11-1/2	2" - 11-1/2

## 1502 ...PIPE SWIVEL 90° ELBOW

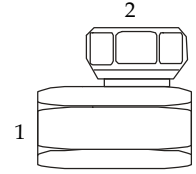

(1) (2)	FEMALE PIPE	FEMALE PIPE
1502-02-02	1/8" - 27	1/8" - 27
1502-02-04	1/8" - 27	1/4" - 18
1502-04-02	1/4" - 18	1/8" - 27
1502-04-04	1/4" - 18	1/4" - 18
1502-04-06	1/4" - 18	3/8" - 18
1502-06-04	3/8" - 18	1/4" - 18
1502-06-06	3/8" - 18	3/8" - 18
1502-06-08	3/8" - 18	1/2" - 14
1502-08-04	1/2" - 14	1/4" - 18
1502-08-06	1/2" - 14	3/8" - 18
1502-08-08	1/2" - 14	1/2" - 14
1502-08-12	1/2" - 14	3/4" - 14
1502-12-06	3/4" - 14	3/8" - 18
1502-12-08	3/4" - 14	1/2" - 14
1502-12-12	3/4" - 14	3/4" - 14
1502-12-16	3/4" - 14	1" - 11-1/2
1502-16-12	1" - 11-1/2	3/4" - 14
1502-16-16	1" - 11-1/2	1" - 11-1/2
1502-20-16	1-1/4" - 11-1/2	1" - 11-1/2
1502-20-20	1-1/4" - 11-1/2	1-1/4" - 11-1/2
1502-24-24	1-1/2" - 11-1/2	1-1/2" - 11-1/2
1502-32-32	2" - 11-1/2	2" - 11-1/2

## 1501 ...PIPE SWIVEL 90° ELBOW (LONG)

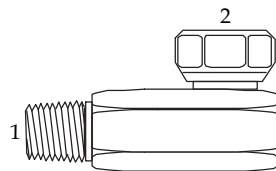

(1) (2)	MALE PIPE	FEMALE PIPE
1501-LL-02-02	1/8" - 27	1/8" - 27
1501-LL-04-04	1/4" - 18	1/4" - 18
1501-LL-06-06	3/8" - 18	3/8" - 18
1501-LL-08-08	1/2" - 14	1/2" - 14
1501-LL-12-12	3/4" - 14	3/4" - 14
1501-LL-16-16	1" - 11-1/2	1" - 11-1/2

## PIPE THREAD

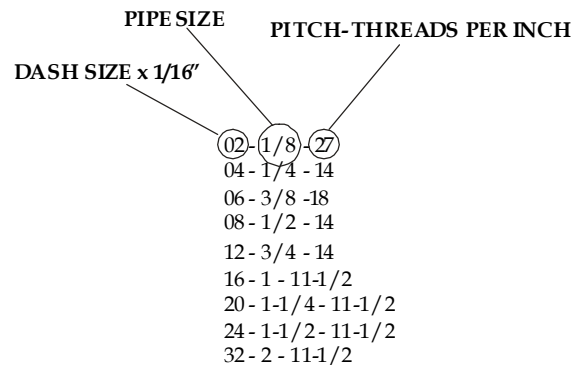

# PIPE THREAD ADAPTERS

## 1503 ...PIPE SWIVEL 45° ELBOW

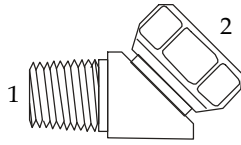

(1) (2)	MALE PIPE	FEMALE PIPE
1503-02-02	1/8" -27	1/8" -27
1503-02-04	1/8" -27	1/4" -18
1503-04-02	1/4" -18	1/8" -27
1503-04-04	1/4" -18	1/4" -18
1503-04-06	1/4" -18	3/8" -18
1503-04-08	1/4" -18	1/2" -14
1503-06-04	3/8" -18	1/4" -18
1503-06-06	3/8" -18	3/8" -18
1503-06-08	3/8" -18	1/2" -14
1503-08-04	1/2" -14	1/4" -18
1503-08-06	1/2" -14	3/8" -18
1503-08-08	1/2" -14	1/2" -14
1503-08-12	1/2" -14	3/4" -14
1503-12-06	3/4" -14	3/8" -18
1503-12-08	3/4" -14	1/2" -14
1503-12-12	3/4" -14	3/4" -14
1503-12-16	3/4" -14	1"-11-1/2
1503-16-12	1" -11-1/2	3/4" -14
1503-16-16	1" -11-1/2	1" -11-1/2
1503-16-20	1" -11-1/2	1-1/4" -11-1/2
1503-20-16	1-1/4" -11-1/2	1" -11-1/2
1503-20-20	1-1/4" -11-1/2	1-1/4" -11-1/2
1503-24-24	1-1/2" -11-1/2	1-1/2" -11-1/2
1503-32-32	2" -11-1/2	2" -11-1/2

## 1504 ...PIPE SWIVEL 45° ELBOW

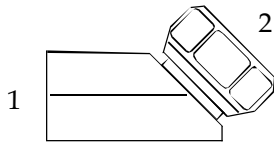

(1) (2)	FEMALE PIPE	FEMALE PIPE
1504-02-02	1/8" -27	1/8" -27
1504-02-04	1/8" -27	1/4" -18
1504-04-02	1/4" -18	1/8" -27
1504-04-04	1/4" -18	1/4" -18
1504-04-06	1/4" -18	3/8" -18
1504-06-04	3/8" -18	1/4" -18
1504-06-06	3/8" -18	3/8" -18
1504-06-08	3/8" -18	1/2" -14
1504-08-06	1/2" -14	3/8" -18
1504-08-08	1/2" -14	1/2" -14
1504-12-08	3/4" -14	1/2" -14
1504-12-12	3/4" -14	3/4" -14
1504-16-12	1" -11-1/2	3/4" -14
1504-16-16	1" -11-1/2	1" -11-1/2
1504-20-20	1-1/4" -11-1/2	1-1/4" -11-1/2
1504-24-24	1-1/2" -11-1/2	1-1/2" -11-1/2
1504-32-32	2" -11-1/2	2" -11-1/2

## 1601 ...PIPE BRANCH TEE SWIVEL UNION

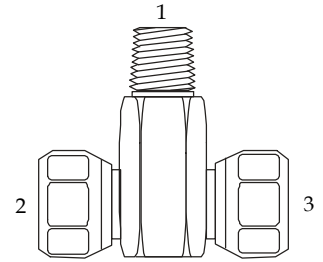

(1) (2) (3)	(1) MALE PIPE	(2)(3) FEMALE PIPE
1601-02-02-02	1/8" -27	1/8" -27
1601-04-04-04	1/4" -18	1/4" -18
1601-04-06-06	1/4" -18	3/8" -18
1601-06-04-04	3/8" -18	1/4" -18
1601-06-06-06	3/8" -18	3/8" -18
1601-06-08-08	3/8" -18	1/2" -14
1601-08-04-04	1/2" -14	1/4" -18
1601-08-06-06	1/2" -14	3/8" -18
1601-08-08-08	1/2" -14	1/2" -14
1601-12-08-08	3/4" -14	1/2" -14
1601-12-12-12	3/4" -14	3/4" -14
1601-16-16-16	1" -11-1/2	1" -11-1/2
1601-20-20-20	1-1/4" -11-1/2	1-1/4" -11-1/2
1601-24-24-24	1-1/2" -11-1/2	1-1/2" -11-1/2

## 1602 ...PIPE BRANCH TEE SWIVEL UNION

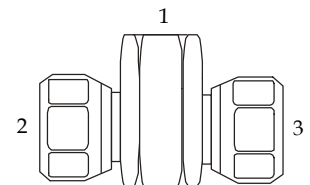

(1) (2) (3)	(1) FEMALE PIPE	(2)(3) FEMALE PIPE
1602-02-02-02	1/8" -27	1/8" -27
1602-04-04-04	1/4" -18	1/4" -18
1602-06-04-04	3/8" -18	1/4" -18
1602-06-06-06	3/8" -18	3/8" -18
1602-08-06-06	1/2" -14	3/8" -18
1602-08-08-08	1/2" -14	1/2" -14
1602-12-08-08	3/4" -14	1/2" -14
1602-12-12-12	3/4" -14	3/4" -14
1602-16-12-12	1" -11-1/2	3/4" -14
1602-16-16-16	1" -11-1/2	1" -11-1/2
1602-20-20-20	1-1/4" -11-1/2	1-1/4" -11-1/2
1602-24-24-24	1-1/2" -11-1/2	1-1/2" -11-1/2

# PIPE THREAD ADAPTERS

## 1603 ...FEMALE PIPE SWIVEL TEE

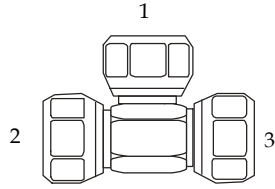

(1) (2) (3)	FEMALE PIPE
1603-02-02-02	1/8" - 27
1603-04-04-04	1/4" - 18
1603-06-06-06	3/8" - 18
1603-08-08-08	1/2" - 14
1603-12-12-12	3/4" - 14
1603-16-16-16	1" - 11-1/2
1603-20-20-20	1-1/4" - 11-1/2

## 5404 ...PIPE HEX NIPPLE

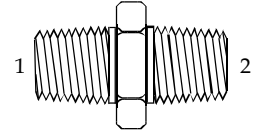

(1) (2)	MALE PIPE	MALE PIPE
5404-02-02	1/8" -27	1/8" -27
5404-04-02	1/4" -18	1/8" -27
5404-04-04	1/4" -18	1/4" -18
5404-06-02	3/8" -18	1/8" -27
5404-06-04	3/8" -18	1/4" -18
5404-06-06	3/8" -18	3/8" -18
5404-08-04	1/2" -14	1/4" -18
5404-08-06	1/2" -14	3/8" -18
5404-08-08	1/2" -14	1/2" -14
5404-12-04	3/4" -14	1/4" -18
5404-12-06	3/4" -14	3/8" -18
5404-12-08	3/4" -14	1/2" -14
5404-12-12	3/4" -14	3/4" -14
5404-16-08	1" -11-1/2	1/2" -14
5404-16-12	1" -11-1/2	3/4" -14
5404-16-16	1" -11-1/2	1" -11-1/2
5404-20-12	1-1/4" -11-1/2	3/4" -14
5404-20-16	1-1/4" -11-1/2	1" -11-1/2
5404-20-20	1-1/4" -11-1/2	1-1/4" -11-1/2
5404-24-12	1-1/2" -11-1/2	3/4" -14
5404-24-16	1-1/2" -11-1/2	1" -11-1/2
5404-24-20	1-1/2" -11-1/2	1-1/4" -11-1/2
5404-24-24	1-1/2" -11-1/2	1-1/2" -11-1/2
5404-32-24	2" -11-1/2	1-1/2" -11-1/2
5404-32-32	2" -11-1/2	2" -11-1/2

## 5000 ...PIPE COUPLING

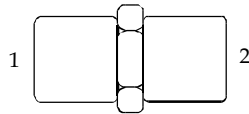

(1) (2)	FEMALE PIPE	FEMALE PIPE
5000-02-02	1/8" - 27	1/8" - 27
5000-04-02	1/4" - 18	1/8" - 27
5000-04-04	1/4" - 18	1/4" - 18
5000-06-02	3/8" - 18	1/8" - 27
5000-06-04	3/8" - 18	1/4" - 18
5000-06-06	3/8" - 18	3/8" - 18
5000-08-04	1/2" - 14	1/4" - 18
5000-08-06	1/2" - 14	3/8" - 18
5000-08-08	1/2" - 14	1/2" - 14
5000-12-06	3/4" - 14	3/8" - 18
5000-12-08	3/4" - 14	1/2" - 14
5000-12-12	3/4" - 14	3/4" - 14
5000-16-08	1" - 11-1/2	1/2" - 14
5000-16-12	1" - 11-1/2	3/4" - 14
5000-16-16	1" - 11-1/2	1" - 11-1/2
5000-20-16	1-1/4" - 11-1/2	1" - 11-1/2
5000-20-20	1-1/4" - 11-1/2	1-1/4" - 11-1/2
5000-24-20	1-1/2" - 11-1/2	1-1/4" - 11-1/2
5000-24-24	1-1/2" - 11-1/2	1-1/2" - 11-1/2
5000-24-32	1-1/2" - 11-1/2	2" - 11-1/2
5000-32-32	2" - 11-1/2	2" - 11-1/2

## PIPE THREAD

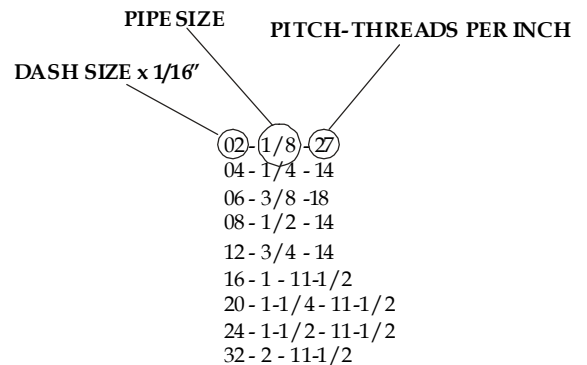

# PIPE THREAD ADAPTERS

## 5405 ...PIPE EXPANDER/REDUCER

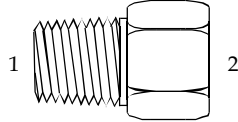

(1) (2)	MALE PIPE	FEMALE PIPE
5405-02-02	1/8" - 27	1/8" - 27
5405-02-04	1/8" - 27	1/4" - 18
5405-02-06	1/8" - 27	3/8" - 18
5405-02-08	1/8" - 27	1/2" - 14
5405-04-02	1/4" - 18	1/8" - 27
5405-04-04	1/4" - 18	1/4" - 18
5405-04-06	1/4" - 18	3/8" - 18
5405-04-08	1/4" - 18	1/2" - 14
5405-04-12	1/4" - 18	3/4" - 14
5405-06-04	3/8" - 18	1/4" - 18
5405-06-06	3/8" - 18	3/8" - 18
5405-06-08	3/8" - 18	1/2" - 14
5405-06-12	3/8" - 18	3/4" - 14
5405-08-04	1/2" - 14	1/4" - 18
5405-08-06	1/2" - 14	3/8" - 18
5405-08-08	1/2" - 14	1/2" - 14
5405-08-12	1/2" - 14	3/4" - 14
5405-08-16	1/2" - 14	1" - 11-1/2
5405-12-04	3/4" - 14	1/4" - 18
5405-12-06	3/4" - 14	3/8" - 18
5405-12-08	3/4" - 14	1/2" - 14
5405-12-12	3/4" - 14	3/4" - 14
5405-12-16	3/4" - 14	1" - 11-1/2
5405-12-20	3/4" - 14	1-1/4" - 11-1/2
5405-16-08	1" - 11-1/2	1/2" - 14
5405-16-12	1" - 11-1/2	3/4" - 14
5405-16-16	1" - 11-1/2	1" - 11-1/2
5405-16-20	1" - 11-1/2	1-1/4" - 11-1/2
5405-16-24	1" - 11-1/2	1-1/2" - 11-1/2
5405-20-12	1-1/4" - 11-1/2	3/4" - 14
5405-20-16	1-1/4" - 11-1/2	1" - 11-1/2
5405-20-20	1-1/4" - 11-1/2	1-1/4" - 11-1/2
5405-20-24	1-1/4" - 11-1/2	1-1/2" - 11-1/2
5405-20-32	1-1/4" - 11-1/2	2" - 11-1/2
5405-24-20	1-1/2" - 11-1/2	1-1/4" - 11-1/2
5405-24-24	1-1/2" - 11-1/2	1-1/2" - 11-1/2
5405-24-32	1-1/2" - 11-1/2	2" - 11-1/2
5405-32-32	2" - 11-1/2	2" - 11-1/2

## 5406 ...HEX REDUCER BUSHING

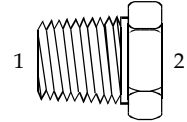

(1) (2)	MALE PIPE	FEMALE PIPE
5406-04-02	1/4" - 18	1/8" - 27
5406-06-02	3/8" - 18	1/8" - 27
5406-06-04	3/8" - 18	1/4" - 18
5406-08-02	1/2" - 14	1/8" - 27
5406-08-04	1/2" - 14	1/4" - 18
5406-08-06	1/2" - 14	3/8" - 18
5406-12-02	3/4" - 14	1/8" - 27
5406-12-04	3/4" - 14	1/4" - 18
5406-12-06	3/4" - 14	3/8" - 18
5406-12-08	3/4" - 14	1/2" - 14
5406-16-02	1" - 11-1/2	1/8" - 27
5406-16-04	1" - 11-1/2	1/4" - 18
5406-16-06	1" - 11-1/2	3/8" - 18
5406-16-08	1" - 11-1/2	1/2" - 14
5406-16-12	1" - 11-1/2	3/4" - 14
5406-20-04	1-1/4" - 11-1/2	1/4" - 18
5406-20-06	1-1/4" - 11-1/2	3/8" - 18
5406-20-08	1-1/4" - 11-1/2	1/2" - 14
5406-20-12	1-1/4" - 11-1/2	3/4" - 14
5406-20-16	1-1/4" - 11-1/2	1" - 11-1/2
5406-24-04	1-1/2" - 11-1/2	1/4" - 18
5406-24-06	1-1/2" - 11-1/2	3/8" - 18
5406-24-08	1-1/2" - 11-1/2	1/2" - 14
5406-24-12	1-1/2" - 11-1/2	3/4" - 14
5406-24-16	1-1/2" - 11-1/2	1" - 11-1/2
5406-24-20	1-1/2" - 11-1/2	1-1/4" - 11-1/2
5406-32-08	2" - 11-1/2	1/2" - 14
5406-32-12	2" - 11-1/2	3/4" - 14
5406-32-16	2" - 11-1/2	1" - 11-1/2
5406-32-20	2" - 11-1/2	1-1/4" - 11-1/2
5406-32-24	2" - 11-1/2	1-1/2" - 11-1/2

## 5406 C ...STEEL PIPE CAP

	FEMALE PIPE
5406-C-02	1/8" - 27
5406-C-04	1/4" - 18
5406-C-06	3/8" - 18
5406-C-08	1/2" - 14
5406-C-12	3/4" - 14
5406-C-16	1" - 11-1/2
5406-C-20	1-1/4" - 11-1/2

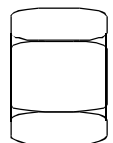



# PIPE THREAD ADAPTERS

## 5406 P ...STEEL PIPE PLUG

	MALE PIPE
5406-P-02	1/8" -27
5406-P-04	1/4" -18
5406-P-06	3/8" -18
5406-P-08	1/2" -14
5406-P-12	3/4" -14
5406-P-16	1" -11-1/2
5406-P-20	1-1/4" -11-1/2
5406-P-24	1-1/2" -11-1/2
5406-P-32	2" -11-1/2

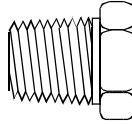

## 5500 ...MALE PIPE 90° ELBOW

(1) (2)	MALE PIPE	MALE PIPE
5500-02-02	1/8" - 27	1/8" - 27
5500-04-02	1/4" - 18	1/8" - 27
5500-04-04	1/4" - 18	1/4" - 18
5500-06-04	3/8" - 18	1/4" - 18
5500-06-06	3/8" - 18	3/8" - 18
5500-08-04	1/2" - 14	1/4" - 18
5500-08-06	1/2" - 14	3/8" - 18
5500-08-08	1/2" - 14	1/2" - 14
5500-12-08	3/4" - 14	1/2" - 14
5500-12-12	3/4" - 14	3/4" - 14
5500-16-08	1" - 11-1/2	1/2" - 14
5500-16-12	1" - 11-1/2	3/4" - 14
5500-16-16	1" - 11-1/2	1" - 11-1/2
5500-20-20	1-1/4" - 11-1/2	1-1/4" - 11-1/2
5500-24-24	1-1/2" - 11-1/2	1-1/2" - 11-1/2

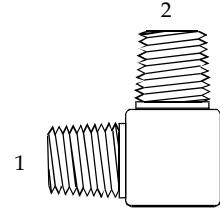

## 5406 HP ...HOLLOW HEX PIPE PLUG

	MALE PIPE
5406-HP-01	1/16" -27
5406-HP-02	1/8" -27
5406-HP-04	1/4" -18
5406-HP-06	3/8" -18
5406-HP-08	1/2" -14
5406-HP-12	3/4" -14
5406-HP-16	1" -11-1/2
5406-HP-20	1-1/4" -11-1/2
5406-HP-24	1-1/2" -11-1/2
5406-HP-32	2" -11-1/2

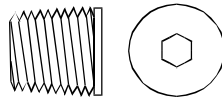

## 5501 ...MALE PIPE 45° ELBOW

(1) (2)	MALE PIPE	MALE PIPE
5501-02-02	1/8" - 27	1/8" - 27
5501-04-04	1/4" - 18	1/4" - 18
5501-06-06	3/8" - 18	3/8" - 18
5501-08-08	1/2" - 14	1/2" - 14
5501-12-12	3/4" - 14	3/4" - 14
5501-16-16	1" - 11-1/2	1" - 11-1/2
5501-20-20	1-1/4" - 11-1/2	1-1/4" - 11-1/2
5501-24-24	1-1/2" - 11-1/2	1-1/2" - 11-1/2
5501-32-32	2" - 11-1/2	2" - 11-1/2

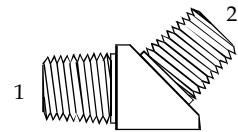

## 5406 SHP ...SQUARE HEAD PIPE PLUG

	MALE PIPE
5406-SHP-02	1/8" -27
5406-SHP-04	1/4" -18
5406-SHP-06	3/8" -18
5406-SHP-08	1/2" -14
5406-SHP-12	3/4" -14
5406-SHP-16	1" -11-1/2

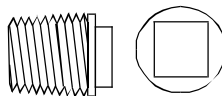

# PIPE THREAD ADAPTERS

## 5502 ..PIPE 90° STREET ELBOW

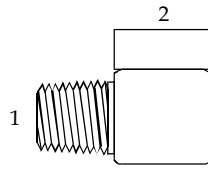

(1) (2)	MALE PIPE	FEMALE PIPE
5502-02-02	1/8" - 27	1/8" - 27
5502-02-04	1/8" - 27	1/4" - 18
5502-02-06	1/8" - 27	3/8" - 18
5502-04-02	1/4" - 18	1/8" - 27
5502-04-04	1/4" - 18	1/4" - 18
5502-04-06	1/4" - 18	3/8" - 18
5502-04-08	1/4" - 18	1/2" - 14
5502-06-02	3/8" - 18	1/8" - 27
5502-06-04	3/8" - 18	1/4" - 18
5502-06-06	3/8" - 18	3/8" - 18
5502-06-08	3/8" - 18	1/2" - 14
5502-08-04	1/2" - 14	1/4" - 18
5502-08-06	1/2" - 14	3/8" - 18
5502-08-08	1/2" - 14	1/2" - 14
5502-08-12	1/2" - 14	3/4" - 14
5502-12-06	3/4" - 14	3/8" - 18
5502-12-08	3/4" - 14	1/2" - 14
5502-12-12	3/4" - 14	3/4" - 14
5502-12-16	3/4" - 14	1" - 11-1/2
5502-16-12	1" - 11-1/2	3/4" - 14
5502-16-16	1" - 11-1/2	1" - 11-1/2
5502-16-20	1" - 11-1/2	1-1/4" - 11-1/2
5502-20-16	1-1/4" - 11-1/2	1" - 11-1/2
5502-20-20	1-1/4" - 11-1/2	1-1/4" - 11-1/2
5502-20-24	1-1/4" - 11-1/2	1-1/2" - 11-1/2
5502-24-20	1-1/2" - 11-1/2	1-1/4" - 11-1/2
5502-24-24	1-1/2" - 11-1/2	1-1/2" - 11-1/2
5502-32-32	2" - 11-1/2	2" - 11-1/2

## 5503 ...PIPE 45° STREET ELBOW

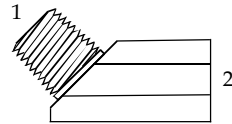

(1) (2)	MALE PIPE	FEMALE PIPE
5503-02-02	1/8" - 27	1/8" - 27
5503-04-04	1/4" - 18	1/4" - 18
5503-06-06	3/8" - 18	3/8" - 18
5503-08-08	1/2" - 14	1/2" - 14
5503-12-12	3/4" - 14	3/4" - 14
5503-16-16	1" - 11-1/2	1" - 11-1/2
5503-20-20	1-1/4" - 11-1/2	1-1/4" - 11-1/2
5503-24-24	1-1/2" - 11-1/2	1-1/2" - 11-1/2

## 5504 ...PIPE 90° ELBOW

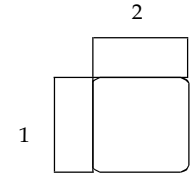

(1) (2)	FEMALE PIPE	FEMALE PIPE
5504-02-02	1/8" - 27	1/8" - 27
5504-04-02	1/4" - 18	1/8" - 27
5504-04-04	1/4" - 18	1/4" - 18
5504-06-04	3/8" - 18	1/4" - 18
5504-06-06	3/8" - 18	3/8" - 18
5504-08-04	1/2" - 14	1/4" - 18
5504-08-06	1/2" - 14	3/8" - 18
5504-08-08	1/2" - 14	1/2" - 14
5504-12-06	3/4" - 14	3/8" - 18
5504-12-08	3/4" - 14	1/2" - 14
5504-12-12	3/4" - 14	3/4" - 14
5504-16-08	1" - 11-1/2	1/2" - 14
5504-16-12	1" - 11-1/2	3/4" - 14
5504-16-16	1" - 11-1/2	1" - 11-1/2
5504-20-12	1-1/4" - 11-1/2	3/4" - 14
5504-20-16	1-1/4" - 11-1/2	1" - 11-1/2
5504-20-20	1-1/4" - 11-1/2	1-1/4" - 11-1/2
5504-24-20	1-1/2" - 11-1/2	1-1/4" - 11-1/2
5504-24-24	1-1/2" - 11-1/2	1-1/2" - 11-1/2
5504-32-32	2" - 11-1/2	2" - 11-1/2

## 5505 ...PIPE 45° ELBOW

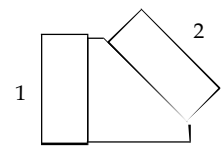

(1) (2)	FEMALE PIPE	FEMALE PIPE
5505-02-02	1/8" - 27	1/8" - 27
5505-04-04	1/4" - 18	1/4" - 18
5505-06-06	3/8" - 18	3/8" - 18
5505-08-08	1/2" - 14	1/2" - 14
5505-12-12	3/4" - 14	3/4" - 14
5505-16-16	1" - 11-1/2	1" - 11-1/2
5505-20-20	1-1/4" - 11-1/2	1-1/4" - 11-1/2

# PIPE THREAD ADAPTERS

## 5600 ...MALE PIPE TEE

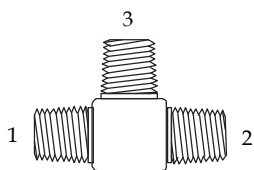

(1) (2) (3)	MALE PIPE
5600-02-02-02	1/8" - 27
5600-04-04-04	1/4" - 18
5600-06-06-06	3/8" - 18
5600-08-08-08	1/2" - 14
5600-12-12-12	3/4" - 14
5600-16-16-16	1" - 11-1/2

## 5603 ...PIPE TEE

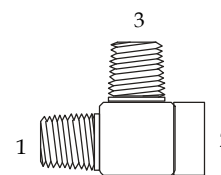

(1) (2) (3)	(1) (3) MALE PIPE	(2) FEMALE PIPE
560B-02-02-02	1/8" - 27	1/8" - 27
560B-04-04-04	1/4" - 18	1/4" - 18
560B-06-06-06	3/8" - 18	3/8" - 18
560B-08-08-08	1/2" - 14	1/2" - 14
560B-12-12-12	3/4" - 14	3/4" - 14
560B-16-16-16	1" - 11-1/2	1" - 11-1/2
560B-20-20-20	1-1/4" - 11-1/2	1-1/4" - 11-1/2
560B-24-24-24	1-1/2" - 11-1/2	1-1/2" - 11-1/2
560B-32-32-32	2" - 11-1/2	2" - 11-1/2

## 5601 ...PIPE TEE

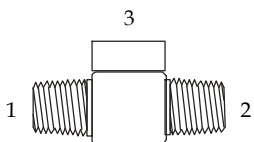

(1) (2) (3)	(1) (2) MALE PIPE	(3) FEMALE PIPE
5601-02-02-02	1/8" - 27	1/8" - 27
5601-04-04-04	1/4" - 18	1/4" - 18
5601-06-06-06	3/8" - 18	3/8" - 18
5601-08-08-08	1/2" - 14	1/2" - 14
5601-12-12-12	3/4" - 14	3/4" - 14
5601-16-16-16	1" - 11-1/2	1" - 11-1/2
5601-20-20-20	1-1/4" - 11-1/2	1-1/4" - 11-1/2
5601-24-24-24	1-1/2" - 11-1/2	1-1/2" - 11-1/2

## 5604 ...PIPE BRANCH TEE

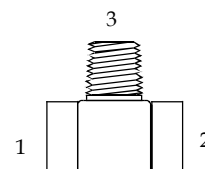

(1) (2) (3)	(1) (2) FEMALE PIPE	(3) MALE PIPE
5604-02-02-02	1/8" - 27	1/8" - 27
5604-04-04-04	1/4" - 18	1/4" - 18
5604-06-06-06	3/8" - 18	3/8" - 18
5604-08-08-08	1/2" - 14	1/2" - 14
5604-12-12-08	3/4" - 14	1/2" - 14
5604-12-12-12	3/4" - 14	3/4" - 14
5604-16-16-16	1" - 11-1/2	1" - 11-1/2
5604-20-20-20	1-1/4" - 11-1/2	1-1/4" - 11-1/2
5604-24-24-24	1-1/2" - 11-1/2	1-1/2" - 11-1/2
5604-32-32-32	2" - 11-1/2	2" - 11-1/2

## 5602 ...PIPE THREAD RUN TEE

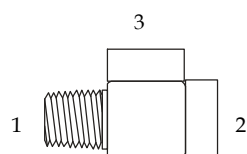

(1) (2) (3)	(1) MALE PIPE	(2) (3) FEMALE PIPE
5602-02-02-02	1/8" - 27	1/8" - 27
5602-02-04-04	1/8" - 27	1/4" - 18
5602-04-04-04	1/4" - 18	1/4" - 18
5602-06-06-06	3/8" - 18	3/8" - 18
5602-08-08-08	1/2" - 14	1/2" - 14
5602-12-12-12	3/4" - 14	3/4" - 14
5602-16-16-16	1" - 11-1/2	1" - 11-1/2
5602-20-20-20	1-1/4" - 11-1/2	1-1/4" - 11-1/2
5602-24-24-24	1-1/2" - 11-1/2	1-1/2" - 11-1/2
5602-32-32-32	2" - 11-1/2	2" - 11-1/2

## 5605 ...PIPE TEE

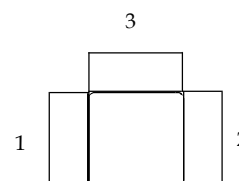

(1) (2) (3)	(1) (2) FEMALE PIPE	(3) FEMALE PIPE
5605-02-02-02	1/8" - 27	1/8" - 27
5605-04-04-02	1/4" - 18	1/8" - 27
5605-04-04-04	1/4" - 18	1/4" - 18
5605-06-06-06	3/8" - 18	3/8" - 18
5605-06-06-08	3/8" - 18	1/2" - 14
5605-08-08-08	1/2" - 14	1/2" - 14
5605-12-12-12	3/4" - 14	3/4" - 14
5605-16-16-16	1" - 11-1/2	1" - 11-1/2
5605-20-20-20	1-1/4" - 11-1/2	1-1/4" - 11-1/2
5605-24-24-24	1-1/2" - 11-1/2	1-1/2" - 11-1/2
5605-32-32-32	2" - 11-1/2	2" - 11-1/2

# PIPE THREAD ADAPTERS

## 5652 ...PIPE CROSS

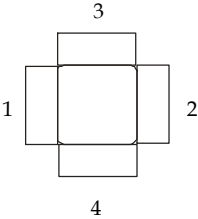

- (1) (2) (3) (4)
- 5652-02-02-02-02
- 5652-04-04-04-04
- 5652-06-06-06-06
- 5652-08-08-08-08
- 5652-12-12-12-12
- 5652-16-16-16-16
- 5652-20-20-20-20
- 5652-24-24-24-24
- 5652-32-32-32-32

- FEMALE PIPE
- 1/8" - 27
  - 1/4" - 18
  - 3/8" - 18
  - 1/2" - 14
  - 3/4" - 14
  - 1" - 11-1/2
  - 1-1/4" - 11-1/2
  - 1-1/2" - 11-1/2
  - 2" - 11-1/2

# JIC 37° FLARE ADAPTERS - QUICK VIEW

Detailed Sizes on the following pages.

**304 C**

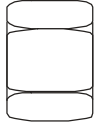

JIC CAP

**306**

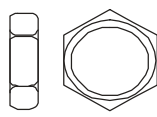

BULKHEAD  
LOCKNUT

**318**

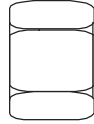

TUBE NUT

**319**

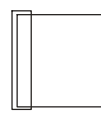

TUBE SLEEVE

**2403**

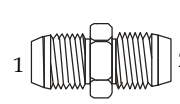

(1)(2) MALE JIC

**2404**

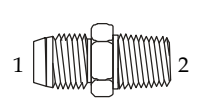

(1) MALE JIC  
(2) MALE NPT

**2405**

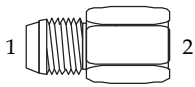

(1) Male JIC  
(2) Female NPT

**2406**

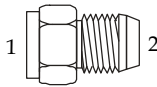

(1) Female JIC  
(2) Male JIC

**2408**

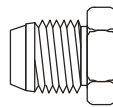

JIC Plug

**2500**

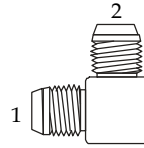

(1) Male JIC  
(2) Male JIC

**2501**

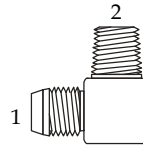

(1) Male JIC  
(2) Male NPT

**2501L**

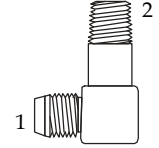

(1) Male JIC  
(2) Male NPT Long

**2501LL**

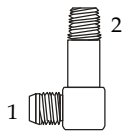

(1) Male JIC  
(2) NPT Extra Long

**2502**

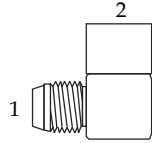

(1) Male JIC  
(2) Female NPT

**2503**

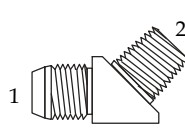

(1) Male JIC  
(2) Male NPT

**2504**

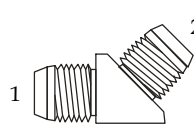

(1) Male JIC  
(2) Male JIC

**2505**

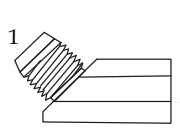

(1) Male JIC  
(2) Female NPT

**2601**

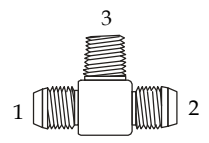

(1) (2) Male JIC  
(2) Male NPT

**2602**

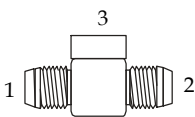

(1) (2) Male JIC  
(2) Female NPT

**2603**

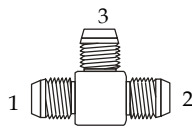

(1)(2)(3) Male JIC

**2605**

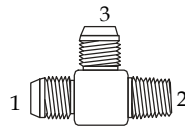

(1)(3) Male JIC  
(2) Male NPT

**2606**

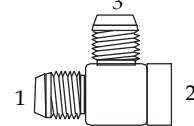

(1)(3) Male JIC  
(2) Female NPT

**2650**

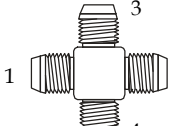

(1)(2)(3)(4) Male JIC

**2700**

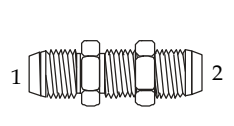

(1) Male JIC  
(2) JIC Bulkhead

**2701**



(1) Male JIC  
(2) JIC Bulkhead

**2702**

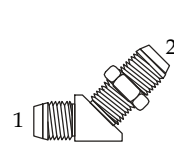

(1) Male JIC  
(2) JIC Bulkhead

**2703**

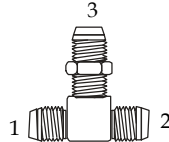

(1)(2) Male JIC  
(3) JIC Bulkhead

**2704**

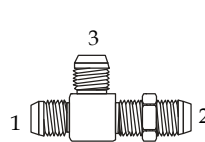

(1)(3) Male JIC  
(2) JIC Bulkhead

**2705**

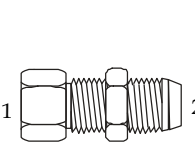

(1) Female NPT  
(2) JIC Bulkhead

**2706**

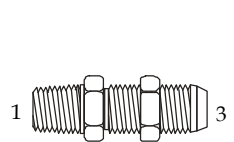

(1) Male NPT  
(2) JIC Bulkhead

**6400**

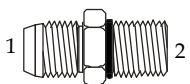

(1) Male JIC  
(2) Male ORB

**6400-L**

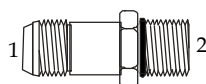

(1) Male JIC  
(2) Male ORB Long

# JIC 37° FLARE ADAPTERS - QUICK VIEW

Detailed Sizes on the following pages.

**6500**

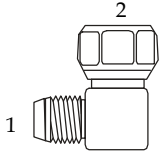

(1) Male JIC  
(2) Female JIC

**6500-L**

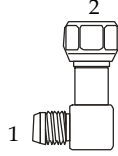

(1) Male JIC  
(2) Female JIC Long

**6501**

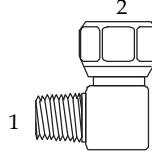

(1) Male NPT  
(2) Female JIC

**6502**

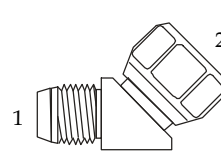

(1) Male JIC  
(2) Female JIC

**6503**

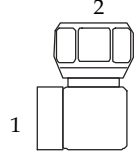

(1) Female NPT  
(2) Female JIC

**6504**

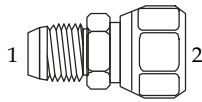

(1) Male JIC  
(2) Female JIC

**6505**

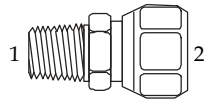

(1) Male NPT  
(2) Female JIC

**6506**

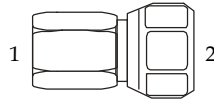

(1) Female NPT  
(2) Female JIC

**6565**

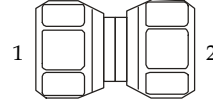

(1) Female JIC  
(2) Female JIC

**6600**

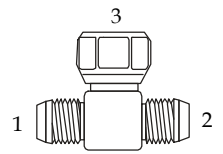

(1)(2) Male JIC  
(3) Female JIC

**6602**

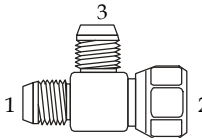

(1)(3) Male JIC  
(2) Female JIC

**6603**

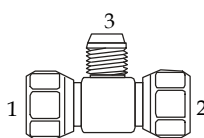

(1)(2) Female JIC  
(3) Male JIC

**6606**

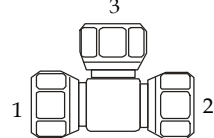

(1)(2)(3) Female JIC

**6701**

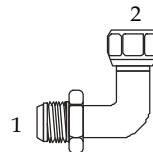

(1) Male JIC  
(2) Female JIC

**6701-L**

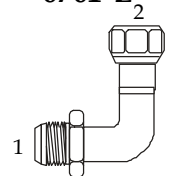

(1) Male JIC  
(2) Female JIC Long

**6801**

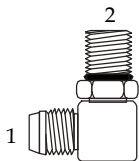

(1) Male JIC  
(2) Male ORB

**6801-L**

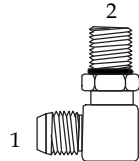

(1) Male JIC  
(2) Male ORB

**6801-LL**

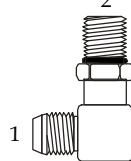

(1) Male JIC  
(2) Male ORB X Long

**6801-LLL**

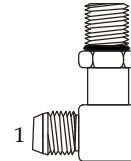

(1) Male JIC  
(2) Male ORB XXL Long

**6802**

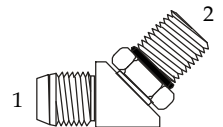

(1) Male JIC  
(2) Male ORB

**6803**

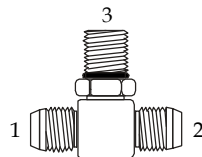

(1)(2) Male JIC  
(3) Male ORB

**6804**

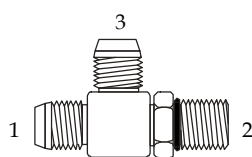

(1)(3) Male JIC  
(2) Male ORB

**6809**

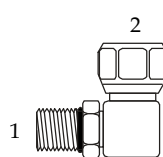

(1) Male ORB  
(2) Female JIC

# JIC 37° FLARE ADAPTERS

## 304C ...JIC CAP

	FEMALE JIC
304C-02	5/16 - 24
304C-03	3/8 - 24
304C-04	7/16 - 20
304C-05	1/2 - 20
304C-06	9/16 - 18
304C-08	3/4 - 16
304C-10	7/8 - 14
304C-12	1-1/16 - 12
304C-14	1-3/16 - 12
304C-16	1-5/16 - 12
304C-20	1-5/8 - 12
304C-24	1-7/8 - 12
304C-32	2-1/2 - 12

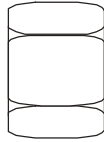

## 319 ...JIC TUBE SLEEVE

	TUBE O.D.
319-02	1/8"
319-03	3/16"
319-04	1/4"
319-05	5/16"
319-06	3/8"
319-08	1/2"
319-10	5/8"
319-12	3/4"
319-14	7/8"
319-16	1"
319-20	1-1/4"
319-24	1-1/2"
319-32	2"

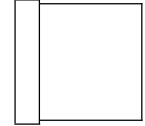

## 306 ...JIC BULHHEAD LOCKNUT

	THREAD
306-02	5/16 - 24
306-03	3/8 - 24
306-04	7/16 - 20
306-05	1/2 - 20
306-06	9/16 - 18
306-08	3/4 - 16
306-10	7/8 - 14
306-12	1-1/16 - 12
306-14	1-3/16 - 12
306-16	1-5/16 - 12
306-20	1-5/8 - 12
306-24	1-7/8 - 12
306-32	2-1/2 - 12

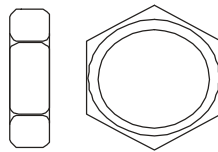

## 0403 ...JIC WELD ADAPTER

(1) (2)	MALE JIC	SOCKET I.D.
0403-04-04	7/16 - 20	1/4"
0403-05-04	1/2 - 20	1/4"
0403-05-05	1/2 - 20	5/16"
0403-06-06	9/16 - 18	3/8"
0403-06-08	9/16 - 18	1/2"
0403-08-06	3/4 - 16	3/8"
0403-08-08	3/4 - 16	1/2"
0403-08-10	3/4 - 16	5/8"
0403-10-08	7/8 - 14	1/2"
0403-10-10	7/8 - 14	5/8"
0403-10-12	7/8 - 14	3/4"
0403-12-08	1-1/16 - 12	1/2"
0403-12-10	1-1/16 - 12	5/8"
0403-12-12	1-1/16 - 12	3/4"
0403-14-14	1-3/16 - 12	7/8"
0403-16-12	1-5/16 - 12	3/4"
0403-16-16	1-5/16 - 12	1"
0403-16-20	1-5/16 - 12	1-1/4"
0403-20-16	1-5/8 - 12	1"
0403-20-20	1-5/8 - 12	1-1/4"
0403-20-24	1-5/8 - 12	1-1/2"
0403-24-20	1-7/8 - 12	1-1/4"
0403-24-24	1-7/8 - 12	1-1/2"
0403-32-32	2-1/2 - 12	2"

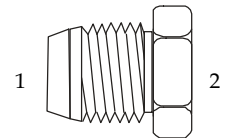

## 318 ...JIC TUBE NUT

	THREAD	TUBE O.D.
318-02	5/16 - 24	1/8"
318-03	3/8 - 24	3/16"
318-04	7/16 - 20	1/4"
318-05	1/2 - 20	5/16"
318-06	9/16 - 18	3/8"
318-08	3/4 - 16	1/2"
318-10	7/8 - 14	5/8"
318-12	1-1/16 - 12	3/4"
318-14	1-3/16 - 12	7/8"
318-16	1-5/16 - 12	1"
318-20	1-5/8 - 12	1-1/4"
318-24	1-7/8 - 12	1-1/2"
318-32	2-1/2 - 12	2"

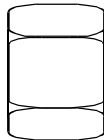

# JIC 37° FLARE ADAPTERS

## 2403 ...JIC UNION

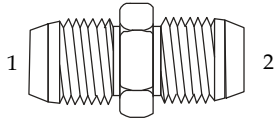

(1) (2)	MALE JIC	MALE JIC
2403-02-02	5/16 - 24	5/16 - 24
2403-03-02	3/8 - 24	5/16 - 24
2403-03-03	3/8 - 24	3/8 - 24
2403-04-02	7/16 - 20	5/16 - 24
2403-04-03	7/16 - 20	3/8 - 24
2403-04-04	7/16 - 20	7/16 - 20
2403-05-04	1/2 - 20	7/16 - 20
2403-05-05	1/2 - 20	1/2 - 20
2403-06-04	9/16 - 18	7/16 - 20
2403-06-05	9/16 - 18	1/2 - 20
2403-06-06	9/16 - 18	9/16 - 18
2403-08-04	3/4 - 16	7/16 - 20
2403-08-05	3/4 - 16	1/2 - 20
2403-08-06	3/4 - 16	9/16 - 18
2403-08-08	3/4 - 16	3/4 - 16
2403-10-04	7/8 - 14	7/16 - 20
2403-10-05	7/8 - 14	1/2 - 20
2403-10-06	7/8 - 14	9/16 - 18
2403-10-08	7/8 - 14	3/4 - 16
2403-10-10	7/8 - 14	7/8 - 14
2403-12-04	1-1/16 - 12	7/16 - 20
2403-12-06	1-1/16 - 12	9/16 - 18
2403-12-08	1-1/16 - 12	3/4 - 16
2403-12-10	1-1/16 - 12	7/8 - 14
2403-12-12	1-1/16 - 12	1-1/16 - 12
2403-14-12	1-3/16 - 12	1-1/16 - 12
2403-14-14	1-3/16 - 12	1-3/16 - 12
2403-16-06	1-5/16 - 12	9/16 - 18
2403-16-08	1-5/16 - 12	3/4 - 16
2403-16-10	1-5/16 - 12	7/8 - 14
2403-16-12	1-5/16 - 12	1-1/16 - 12
2403-16-14	1-5/16 - 12	1-3/16 - 12
2403-16-16	1-5/16 - 12	1-5/16 - 12
2403-20-12	1-5/8 - 12	1-1/16 - 12
2403-20-16	1-5/8 - 12	1-5/16 - 12
2403-20-20	1-5/8 - 12	1-5/8 - 12
2403-24-12	1-7/8 - 12	1-1/16 - 12
2403-24-16	1-7/8 - 12	1-5/16 - 12
2403-24-20	1-7/8 - 12	1-5/8 - 12
2403-24-24	1-7/8 - 12	1-7/8 - 12
2403-32-16	2-1/2 - 12	1-5/16 - 12
2403-32-20	2-1/2 - 12	1-5/8 - 12
2403-32-24	2-1/2 - 12	1-7/8 - 12
2403-32-32	2-1/2 - 12	2-1/2 - 12

## 2404 ...JIC 37° - PIPE UNION

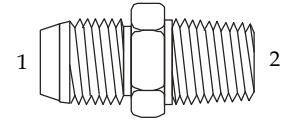

(1) (2)	MALE JIC	MALE PIPE
2404-02-02	5/16 - 24	1/8" - 27
2404-02-04	5/16 - 24	1/4" - 18
2404-03-02	3/8 - 24	1/8" - 27
2404-03-04	3/8 - 24	1/4" - 18
2404-04-02	7/16 - 20	1/8" - 27
2404-04-04	7/16 - 20	1/4" - 18
2404-04-06	7/16 - 20	3/8" - 18
2404-04-08	7/16 - 20	1/2" - 14
2404-04-12	7/16 - 20	3/4" - 14
2404-05-02	1/2 - 20	1/8" - 27
2404-05-04	1/2 - 20	1/4" - 18
2404-05-06	1/2 - 20	3/8" - 18
2404-05-08	1/2 - 20	1/2" - 14
2404-06-02	9/16 - 18	1/8" - 27
2404-06-04	9/16 - 18	1/4" - 18
2404-06-06	9/16 - 18	3/8" - 18
2404-06-08	9/16 - 18	1/2" - 14
2404-06-12	9/16 - 18	3/4" - 14
2404-08-02	3/4 - 16	1/8" - 27
2404-08-04	3/4 - 16	1/4" - 18
2404-08-06	3/4 - 16	3/8" - 18
2404-08-08	3/4 - 16	1/2" - 14
2404-08-12	3/4 - 16	3/4" - 14
2404-08-16	3/4 - 16	1" - 11-1/2
2404-10-04	7/8 - 14	1/4" - 18
2404-10-06	7/8 - 14	3/8" - 18
2404-10-08	7/8 - 14	1/2" - 14
2404-10-12	7/8 - 14	3/4" - 14
2404-10-16	7/8 - 14	1" - 11-1/2
2404-12-06	1-1/16 - 12	3/8" - 18
2404-12-08	1-1/16 - 12	1/2" - 14
2404-12-12	1-1/16 - 12	3/4" - 14
2404-12-16	1-1/16 - 12	1" - 11-1/2
2404-12-20	1-1/16 - 12	1-1/4" - 11-1/2
2404-12-24	1-1/16 - 12	1-1/2" - 11-1/2
2404-14-08	1-3/16 - 12	1/2" - 14
2404-14-12	1-3/16 - 12	3/4" - 14
2404-14-16	1-3/16 - 12	1" - 11-1/2
2404-16-08	1-5/16 - 12	1/2" - 14
2404-16-12	1-5/16 - 12	3/4" - 14
2404-16-16	1-5/16 - 12	1" - 11-1/2
2404-16-20	1-5/16 - 12	1-1/4" - 11-1/2
2404-16-24	1-5/16 - 12	1-1/2" - 11-1/2
2404-20-12	1-5/8 - 12	3/4" - 14
2404-20-16	1-5/8 - 12	1" - 11-1/2
2404-20-20	1-5/8 - 12	1-1/4" - 11-1/2
2404-20-24	1-5/8 - 12	1-1/2" - 11-1/2
2404-20-32	1-5/8 - 12	2" - 11-1/2
2404-24-12	1-7/8 - 12	3/4" - 14
2404-24-16	1-7/8 - 12	1" - 11-1/2
2404-24-20	1-7/8 - 12	1-1/4" - 11-1/2
2404-24-24	1-7/8 - 12	1-1/2" - 11-1/2
2404-24-32	1-7/8 - 12	2" - 11-1/2
2404-32-12	2-1/2 - 12	3/4" - 14
2404-32-16	2-1/2 - 12	1" - 11-1/2
2404-32-20	2-1/2 - 12	1-1/4" - 11-1/2
2404-32-24	2-1/2 - 12	1-1/2" - 11-1/2
2404-32-32	2-1/2 - 12	2" - 11-1/2



# JIC 37° FLARE ADAPTERS

## 2405 ...JIC - FEMALE PIPE

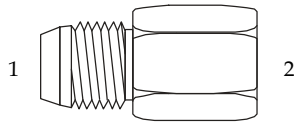

(1) (2)	MALE JIC	FEMALE PIPE
2405-02-02	5/16 - 24	1/8" - 27
2405-03-02	3/8 - 24	1/8" - 27
2405-03-04	3/8 - 24	1/4" - 18
2405-04-02	7/16 - 20	1/8" - 27
2405-04-04	7/16 - 20	1/4" - 18
2405-04-06	7/16 - 20	3/8" - 18
2405-04-08	7/16 - 20	1/2" - 14
2405-05-02	1/2 - 20	1/8" - 27
2405-05-04	1/2 - 20	1/4" - 18
2405-06-02	9/16 - 18	1/8" - 27
2405-06-04	9/16 - 18	1/4" - 18
2405-06-06	9/16 - 18	3/8" - 18
2405-06-08	9/16 - 18	1/2" - 14
2405-08-04	3/4 - 16	1/4" - 18
2405-08-06	3/4 - 16	3/8" - 18
2405-08-08	3/4 - 16	1/2" - 14
2405-08-12	3/4 - 16	3/4" - 14
2405-10-06	7/8 - 14	3/8" - 18
2405-10-08	7/8 - 14	1/2" - 14
2405-10-12	7/8 - 14	3/4" - 14
2405-12-08	1-1/16 - 12	1/2" - 14
2405-12-12	1-1/16 - 12	3/4" - 14
2405-12-16	1-1/16 - 12	1" - 11-1/2
2405-14-12	1-3/16 - 12	3/4" - 14
2405-16-12	1-5/16 - 12	3/4" - 14
2405-16-16	1-5/16 - 12	1" - 11-1/2
2405-16-20	1-5/16 - 12	1-1/4" - 11-1/2
2405-20-16	1-5/8 - 12	1" - 11-1/2
2405-20-20	1-5/8 - 12	1-1/4" - 11-1/2
2405-20-24	1-5/8 - 12	1-1/2" - 11-1/2
2405-24-20	1-7/8 - 12	1-1/4" - 11-1/2
2405-24-24	1-7/8 - 12	1-1/2" - 11-1/2
2405-32-32	2-1/2 - 12	2" - 11-1/2

## 2406 ...JIC REDUCER/ EXPANDER

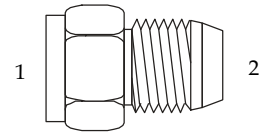

(1) (2)	FEMALE JIC	MALE JIC
2406-03-04	3/8 - 24	7/16 - 20
2406-04-03	7/16 - 20	3/8 - 24
2406-04-06	7/16 - 20	9/16 - 18
2406-05-04	1/2 - 20	7/16 - 20
2406-06-04	9/16 - 18	7/16 - 20
2406-06-05	9/16 - 18	1/2 - 20
2406-06-08	9/16 - 18	3/4 - 16
2406-08-04	3/4 - 16	7/16 - 20
2406-08-05	3/4 - 16	1/2 - 20
2406-08-06	3/4 - 16	9/16 - 18
2406-08-10	3/4 - 16	7/8 - 14
2406-08-12	3/4 - 16	1-1/16 - 12
2406-10-04	7/8 - 14	7/16 - 20
2406-10-06	7/8 - 14	9/16 - 18
2406-10-08	7/8 - 14	3/4 - 16
2406-10-12	7/8 - 14	1-1/16 - 12
2406-12-04	1-1/16 - 12	7/16 - 20
2406-12-06	1-1/16 - 12	9/16 - 18
2406-12-08	1-1/16 - 12	3/4 - 16
2406-12-10	1-1/16 - 12	7/8 - 14
2406-12-16	1-1/16 - 12	1-5/16 - 12
2406-14-06	1-3/16 - 12	9/16 - 18
2406-14-08	1-3/16 - 12	3/4 - 16
2406-14-10	1-3/16 - 12	7/8 - 14
2406-14-12	1-3/16 - 12	1-1/16 - 12
2406-16-04	1-5/16 - 12	7/16 - 20
2406-16-06	1-5/16 - 12	9/16 - 18
2406-16-08	1-5/16 - 12	3/4 - 16
2406-16-10	1-5/16 - 12	7/8 - 14
2406-16-12	1-5/16 - 12	1-1/16 - 12
2406-16-14	1-5/16 - 12	1-3/16 - 12
2406-16-20	1-5/16 - 12	1-5/8 - 12
2406-20-08	1-5/8 - 12	3/4 - 16
2406-20-10	1-5/8 - 12	7/8 - 14
2406-20-12	1-5/8 - 12	1-1/16 - 12
2406-20-16	1-5/8 - 12	1-5/16 - 12
2406-20-24	1-5/8 - 12	1-7/8 - 12
2406-24-08	1-7/8 - 12	3/4 - 16
2406-24-12	1-7/8 - 12	1-1/16 - 12
2406-24-16	1-7/8 - 12	1-5/16 - 12
2406-24-20	1-7/8 - 12	1-5/8 - 12
2406-32-24	2-1/2 - 12	1-7/8 - 12

# JIC 37° FLARE ADAPTERS

## 2408 ...JIC HEX PLUG

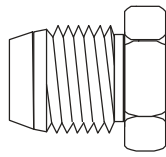

	MALE JIC
2408-02	5/16 - 24
2408-03	3/8 - 24
2408-04	7/16 - 20
2408-05	1/2 - 20
2408-06	9/16 - 18
2408-08	3/4 - 16
2408-10	7/8 - 14
2408-12	1-1/16 - 12
2408-14	1-3/16 - 12
2408-16	1-5/16 - 12
2408-20	1-5/8 - 12
2408-24	1-7/8 - 12
2408-32	2-1/2 - 12

## 2501 ...JIC - PIPE 90° ELBOW

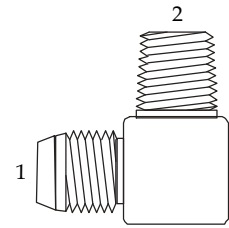

(1) (2)	MALE JIC	MALE PIPE
2501-02-02	5/16 - 24	1/8" - 27
2501-03-02	3/8 - 24	1/8" - 27
2501-04-02	7/16 - 20	1/8" - 27
2501-04-04	7/16 - 20	1/4" - 18
2501-04-06	7/16 - 20	3/8" - 18
2501-04-08	7/16 - 20	1/2" - 14
2501-04-12	7/16 - 20	3/4" - 14
2501-05-02	1/2 - 20	1/8" - 27
2501-05-04	1/2 - 20	1/4" - 18
2501-05-06	1/2 - 20	3/8" - 18
2501-05-08	1/2 - 20	1/2" - 14
2501-06-02	9/16 - 18	1/8" - 27
2501-06-04	9/16 - 18	1/4" - 18
2501-06-06	9/16 - 18	3/8" - 18
2501-06-08	9/16 - 18	1/2" - 14
2501-06-12	9/16 - 18	3/4" - 14
2501-08-02	3/4 - 16	1/8" - 27
2501-08-04	3/4 - 16	1/4" - 18
2501-08-06	3/4 - 16	3/8" - 18
2501-08-08	3/4 - 16	1/2" - 14
2501-08-12	3/4 - 16	3/4" - 14
2501-08-16	3/4 - 16	1" - 11-1/2
2501-10-06	7/8 - 14	3/8" - 18
2501-10-08	7/8 - 14	1/2" - 14
2501-10-12	7/8 - 14	3/4" - 14
2501-10-16	7/8 - 14	1" - 11-1/2
2501-12-06	1-1/16 - 12	3/8" - 18
2501-12-08	1-1/16 - 12	1/2" - 14
2501-12-12	1-1/16 - 12	3/4" - 14
2501-12-16	1-1/16 - 12	1" - 11-1/2
2501-14-12	1-3/16 - 12	3/4" - 14
2501-16-06	1-5/16 - 12	3/8" - 18
2501-16-08	1-5/16 - 12	1/2" - 14
2501-16-12	1-5/16 - 12	3/4" - 14
2501-16-16	1-5/16 - 12	1" - 11-1/2
2501-16-20	1-5/16 - 12	1-1/4" - 11-1/2
2501-16-24	1-5/16 - 12	1-1/2" - 11-1/2
2501-20-16	1-5/8 - 12	1" - 11-1/2
2501-20-20	1-5/8 - 12	1-1/4" - 11-1/2
2501-20-24	1-5/8 - 12	1-1/2" - 11-1/2
2501-24-16	1-7/8 - 12	1" - 11-1/2
2501-24-20	1-7/8 - 12	1-1/4" - 11-1/2
2501-24-24	1-7/8 - 12	1-1/2" - 11-1/2
2501-24-32	1-7/8 - 12	2" - 11-1/2
2501-32-24	2-1/2 - 12	1-1/2" - 11-1/2
2501-32-32	2-1/2 - 12	2" - 11-1/2

## 2500 ...JIC UNION 90° ELBOW

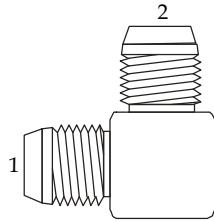

(1) (2)	MALE JIC	MALE JIC
2500-02-02	5/16 - 24	5/16 - 24
2500-03-03	3/8 - 24	3/8 - 24
2500-04-04	7/16 - 20	7/16 - 20
2500-05-04	1/2 - 20	7/16 - 20
2500-05-05	1/2 - 20	1/2 - 20
2500-06-04	9/16 - 18	7/16 - 20
2500-06-05	9/16 - 18	1/2 - 20
2500-06-06	9/16 - 18	9/16 - 18
2500-08-04	3/4 - 16	7/16 - 20
2500-08-06	3/4 - 16	9/16 - 20
2500-08-08	3/4 - 16	3/4 - 16
2500-10-08	7/8 - 14	3/4 - 16
2500-10-10	7/8 - 14	7/8 - 14
2500-12-06	1-1/16 - 12	9/16 - 20
2500-12-08	1-1/16 - 12	3/4 - 16
2500-12-10	1-1/16 - 12	7/8 - 14
2500-12-12	1-1/16 - 12	1-1/16 - 12
2500-14-14	1-3/16 - 12	1-3/16 - 12
2500-16-12	1-5/16 - 12	1-1/16 - 12
2500-16-16	1-5/16 - 12	1-5/16 - 12
2500-20-20	1-5/8 - 12	1-5/8 - 12
2500-24-24	1-7/8 - 12	1-7/8 - 12
2500-32-32	2-1/2 - 12	2-1/2 - 12

# JIC 37° FLARE ADAPTERS

## 2501L ...JIC - PIPE 90° ELBOW LONG

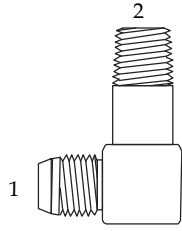

(1) (2)	MALE JIC	MALE PIPE
2501-L-04-02	7/16 - 20	1/8" - 27
2501-L-04-04	7/16 - 20	1/4" - 18
2501-L-05-02	1/2 - 20	1/8" - 27
2501-L-05-04	1/2 - 20	1/4" - 18
2501-L-06-02	9/16 - 18	1/8" - 27
2501-L-06-04	9/16 - 18	1/4" - 18
2501-L-06-06	9/16 - 18	3/8" - 18
2501-L-06-08	9/16 - 18	1/2" - 14
2501-L-08-04	3/4 - 16	1/4" - 18
2501-L-08-06	3/4 - 16	3/8" - 18
2501-L-08-08	3/4 - 16	1/2" - 14
2501-L-08-12	3/4 - 16	3/4" - 14
2501-L-10-08	7/8 - 14	1/2" - 14
2501-L-10-12	7/8 - 14	3/4" - 14
2501-L-12-08	1-1/16 - 12	1/2" - 14
2501-L-12-12	1-1/16 - 12	3/4" - 14
2501-L-12-16	1-1/16 - 12	1" - 11-1/2
2501-L-14-12	1-3/16 - 12	3/4" - 14
2501-L-16-12	1-5/16 - 12	3/4" - 14
2501-L-16-16	1-5/16 - 12	1" - 11-1/2
2501-L-20-20	1-5/8 - 12	1-1/4" - 11-1/2
2501-L-24-24	1-7/8 - 12	1-1/2" - 11-1/2

## 2501LL ...JIC - PIPE 90° ELBOW X LONG

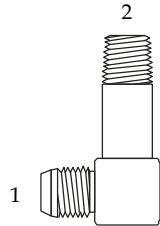

(1) (2)	MALE JIC	MALE PIPE
2501-LL-04-02	7/16 - 20	1/8" - 27
2501-LL-04-04	7/16 - 20	1/4" - 18
2501-LL-05-02	1/2 - 20	1/8" - 27
2501-LL-05-04	1/2 - 20	1/4" - 18
2501-LL-06-04	9/16 - 18	1/4" - 18
2501-LL-06-06	9/16 - 18	3/8" - 18
2501-LL-06-08	9/16 - 18	1/2" - 14
2501-LL-08-06	3/4 - 16	3/8" - 18
2501-LL-08-08	3/4 - 16	1/2" - 14
2501-LL-10-08	7/8 - 14	1/2" - 14
2501-LL-12-08	1-1/16 - 12	1/2" - 14
2501-LL-12-12	1-1/16 - 12	3/4" - 14
2501-LL-16-12	1-5/16 - 12	3/4" - 14
2501-LL-16-16	1-5/16 - 12	1" - 11-1/2
2501-LL-20-20	1-5/8 - 12	1-1/4" - 11-1/2
2501-LL-24-24	1-7/8 - 12	1-1/2" - 11-1/2
2501-LL-32-32	2-1/2 - 12	2" - 11-1/2

## 2501LLL ...JIC - PIPE 90° ELBOW XX LONG

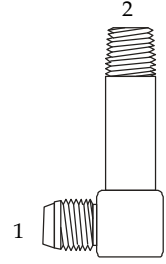

(1) (2)	MALE JIC	MALE PIPE
2501-LLL-04-02	7/16 - 20	1/8" - 27
2501-LLL-04-04	7/16 - 20	1/4" - 18
2501-LLL-05-02	1/2 - 20	1/8" - 27
2501-LLL-06-04	9/16 - 18	1/4" - 18
2501-LLL-06-06	9/16 - 18	3/8" - 18
2501-LLL-08-06	3/4 - 16	3/8" - 18
2501-LLL-08-08	3/4 - 16	1/2" - 14
2501-LLL-10-08	7/8 - 14	1/2" - 14
2501-LLL-12-12	1-1/16 - 12	3/4" - 14
2501-LLL-16-16	1-5/16 - 12	1" - 11-1/2
2501-LLL-20-20	1-5/8 - 12	1-1/4" - 11-1/2

## 2502 ...JIC - PIPE 90° ELBOW

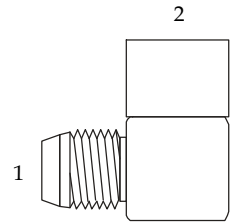

(1) (2)	MALE JIC	FEMALE PIPE
2502-02-02	5/16 - 24	1/8" - 27
2502-03-02	3/8 - 24	1/8" - 27
2502-04-02	7/16 - 20	1/8" - 27
2502-04-04	7/16 - 20	1/4" - 18
2502-04-06	7/16 - 20	3/8" - 18
2502-05-02	1/2 - 20	1/8" - 27
2502-05-04	1/2 - 20	1/4" - 18
2502-06-02	9/16 - 18	1/8" - 27
2502-06-04	9/16 - 18	1/4" - 18
2502-06-06	9/16 - 18	3/8" - 18
2502-06-08	9/16 - 18	1/2" - 14
2502-08-04	3/4 - 16	1/4" - 18
2502-08-06	3/4 - 16	3/8" - 18
2502-08-08	3/4 - 16	1/2" - 14
2502-08-12	3/4 - 16	3/4" - 14
2502-10-08	7/8 - 14	1/2" - 14
2502-12-08	1-1/16 - 12	1/2" - 14
2502-12-12	1-1/16 - 12	3/4" - 14
2502-12-16	1-1/16 - 12	1" - 11-1/2
2502-14-12	1-3/16 - 12	3/4" - 14
2502-16-12	1-5/16 - 12	3/4" - 14
2502-16-16	1-5/16 - 12	1" - 11-1/2
2502-20-20	1-5/8 - 12	1-1/4" - 11-1/2
2502-24-24	1-7/8 - 12	1-1/2" - 11-1/2
2502-32-32	2-1/2 - 12	2" - 11-1/2

# JIC 37° FLARE ADAPTERS

## 2503 ...JIC - PIPE 45° ELBOW

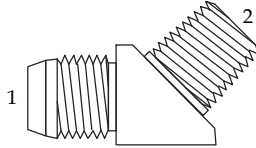

(1) (2)	MALE JIC	MALE PIPE
2503-02-02	5/16 -24	1/8" -27
2503-03-02	3/8 -24	1/8" -27
2503-04-02	7/16 -20	1/8" -27
2503-04-04	7/16 -20	1/4" -18
2503-04-06	7/16 -20	3/8" -18
2503-04-08	7/16 -20	1/2" -14
2503-05-02	1/2 -20	1/8" -27
2503-05-04	1/2 -20	1/4" -18
2503-06-02	9/16 -18	1/8" -27
2503-06-04	9/16 -18	1/4" -18
2503-06-06	9/16 -18	3/8" -18
2503-06-08	9/16 -18	1/2" -14
2503-06-12	9/16 -18	3/4" -14
2503-08-04	3/4 -16	1/4" -18
2503-08-06	3/4 -16	3/8" -18
2503-08-08	3/4 -16	1/2" -14
2503-08-12	3/4 -16	3/4" -14
2503-10-06	7/8 -14	3/8" -18
2503-10-08	7/8 -14	1/2" -14
2503-10-12	7/8 -14	3/4" -14
2503-12-08	1-1/16 -12	1/2" -14
2503-12-12	1-1/16 -12	3/4" -14
2503-12-16	1-1/16 -12	1" -11-1/2
2503-14-12	1-3/16 -12	3/4" -14
2503-16-08	1-5/16 -12	1/2" -14
2503-16-12	1-5/16 -12	3/4" -14
2503-16-16	1-5/16 -12	1" -11-1/2
2503-16-20	1-5/16 -12	1-1/4" -11-1/2
2503-20-16	1-5/8 -12	1" -11-1/2
2503-20-20	1-5/8 -12	1-1/4" -11-1/2
2503-20-24	1-5/8 -12	1-1/2" -11-1/2
2503-24-24	1-7/8 -12	1-1/2" -11-1/2
2503-32-32	2-1/2 -12	2" -11-1/2

## 2504 ...JIC 45° ELBOW

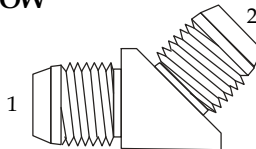

	(1) MALE JIC	(2) MALE JIC
2504-03-03	3/8 -24	3/8 -24
2504-04-04	7/16 -20	7/16 -20
2504-06-04	9/16 -18	7/16 -20
2504-06-06	9/16 -18	9/16 -18
2504-08-08	3/4 -16	3/4 -16
2504-10-10	7/8 -14	7/8 -14
2504-12-12	1-1/16 -12	1-1/16 -12
2504-16-16	1-5/16 -12	1-5/16 -12

## 2505 ...JIC - PIPE 45° ELBOW

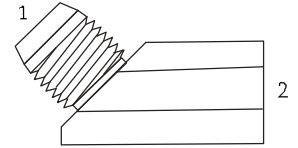

(1) (2)	(1) MALE JIC	(2) FEMALE PIPE
2505-04-02	7/16 -20	1/8 -27
2505-04-04	7/16 -20	1/4 -18
2505-06-04	9/16 -18	1/4 -18
2505-06-06	9/16 -18	3/8 -18
2505-08-06	3/4 -16	3/8 -18
2505-08-08	3/4 -16	1/2 -14
2505-10-08	7/8 -14	1/2 -14
2505-12-12	1-1/16 -12	3/4 -14
2505-16-16	1-5/16 -12	1" -11-1/2

## 2601 ...JIC - PIPE BRANCH TEE

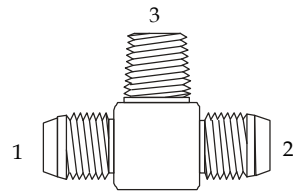

(1) (2) (3)	(1) (2) MALE JIC	MALE PIPE
2601-03-03-02	3/8 -24	1/8" -27
2601-04-04-02	7/16 -20	1/8" -27
2601-04-04-04	7/16 -20	1/4" -18
2601-04-04-06	7/16 -20	3/8" -18
2601-05-05-02	1/2 -20	1/8" -27
2601-05-05-04	1/2 -20	1/4" -18
2601-06-06-04	9/16 -18	1/4" -18
2601-06-06-06	9/16 -18	3/8" -18
2601-06-06-08	9/16 -18	1/2" -14
2601-08-08-06	3/4 -16	3/8" -18
2601-08-08-08	3/4 -16	1/2" -14
2601-10-10-06	7/8 -14	3/8" -18
2601-10-10-08	7/8 -14	1/2" -14
2601-12-12-08	1-1/16 -12	1/2" -14
2601-12-12-12	1-1/16 -12	3/4" -14
2601-14-14-12	1-3/16 -12	3/4" -14
2601-16-16-12	1-5/16 -12	3/4" -14
2601-16-16-16	1-5/16 -12	1" -11-1/2
2601-20-20-20	1-5/8 -12	1-1/4" -11-1/2
2601-24-24-24	1-7/8 -12	1-1/2" -11-1/2
2601-32-32-32	2-1/2 -12	2" -11-1/2

# JIC 37° FLARE ADAPTERS

## 2602 ...JIC - PIPE BRANCH TEE

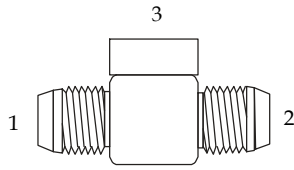

(1) (2) (3)	MALE JIC	FEMALE PIPE
2602-04-04-02	7/16 - 20	1/8" - 27
2602-04-04-04	7/16 - 20	1/4" - 18
2602-05-05-02	1/2 - 20	1/8" - 27
2602-05-05-04	1/2 - 20	1/4" - 18
2602-06-06-04	9/16 - 18	1/4" - 18
2602-06-06-06	9/16 - 18	3/8" - 18
2602-08-08-06	3/4 - 16	3/8" - 18
2602-08-08-04	3/4 - 16	1/4" - 18
2602-08-08-08	3/4 - 16	1/2" - 14
2602-10-10-08	7/8 - 14	1/2" - 14
2602-12-12-12	1-1/16 - 12	3/4" - 14
2602-16-16-16	1-5/16 - 12	1" - 11-1/2
2602-20-20-20	1-5/8 - 12	1-1/4" - 11-1/2
2602-24-24-24	1-7/8 - 12	1-1/2" - 11-1/2
2602-32-32-32	2-1/2 - 12	2" - 11-1/2

## 2605 ...JIC - PIPE RUN TEE

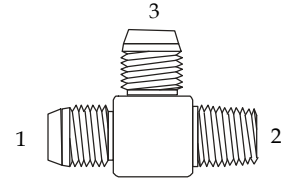

(1) (2) (3)	MALE JIC	MALE PIPE	MALE JIC
2605-03-02-03	3/8 - 24	1/8" - 27	3/8 - 24
2605-04-02-04	7/16 - 20	1/8" - 27	7/16 - 20
2605-04-04-04	7/16 - 20	1/4" - 18	7/16 - 20
2605-05-02-05	1/2 - 20	1/8" - 27	1/2 - 20
2605-05-04-05	1/2 - 20	1/4" - 18	1/2 - 20
2605-06-02-06	9/16 - 18	1/8" - 27	9/16 - 18
2605-06-04-04	9/16 - 18	1/4" - 18	7/16 - 20
2605-06-04-06	9/16 - 18	1/4" - 18	9/16 - 18
2605-06-06-06	9/16 - 18	3/8" - 18	9/16 - 18
2605-06-08-06	9/16 - 18	1/2" - 14	9/16 - 18
2605-08-04-08	3/4 - 16	1/4" - 18	3/4 - 16
2605-08-06-08	3/4 - 16	3/8" - 18	3/4 - 16
2605-08-08-06	3/4 - 16	1/2" - 14	9/16 - 18
2605-08-08-08	3/4 - 16	1/2" - 14	3/4 - 16
2605-10-08-10	7/8 - 14	1/2" - 14	7/8 - 14
2605-12-08-12	1-1/16 - 12	1/2" - 14	1-1/16 - 12
2605-12-12-08	1-1/16 - 12	3/4" - 14	7/8 - 14
2605-12-12-12	1-1/16 - 12	3/4" - 14	1-1/16 - 12
2605-14-12-14	1-3/16 - 12	3/4" - 14	1-3/16 - 12

## 2603 ...JIC UNION TEE

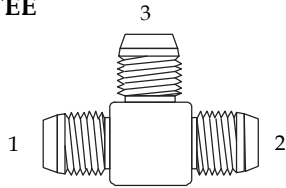

(1) (2) (3)	(1)(2) MALE JIC	(3) MALE JIC
2603-02-02-02	5/16 - 24	5/16 - 24
2603-03-03-03	3/8 - 24	3/8 - 24
2603-04-04-04	7/16 - 20	7/16 - 20
2603-04-04-06	7/16 - 20	9/16 - 18
2603-05-05-05	1/2 - 20	1/2 - 20
2603-06-06-04	9/16 - 18	7/16 - 20
2603-06-06-06	9/16 - 18	9/16 - 18
2603-06-06-08	9/16 - 18	3/4 - 16
2603-08-08-06	3/4 - 16	9/16 - 18
2603-08-08-08	3/4 - 16	3/4 - 16
2603-08-08-10	3/4 - 16	7/8 - 14
2603-08-08-12	3/4 - 16	1-1/16 - 12
2603-10-10-08	7/8 - 14	3/4 - 16
2603-10-10-10	7/8 - 14	7/8 - 14
2603-12-12-08	1-1/16 - 12	3/4 - 16
2603-12-12-10	1-1/16 - 12	7/8 - 14
2603-12-12-12	1-1/16 - 12	1-1/16 - 12
2603-14-14-14	1-3/16 - 12	1-3/16 - 12
2603-16-16-12	1-5/16 - 12	1-1/16 - 12
2603-16-16-16	1-5/16 - 12	1-5/16 - 12
2603-16-16-20	1-5/16 - 12	1-5/8 - 12
2603-20-16-16	1-5/8 - 12	1-5/16 - 12
2603-20-20-16	1-5/8 - 12	1-5/16 - 12
2603-20-20-20	1-5/8 - 12	1-5/8 - 12
2603-24-24-24	1-7/8 - 12	1-7/8 - 12
2603-32-32-32	2-1/2 - 12	2-1/2 - 12

## 2606 ...JIC - PIPE RUN TEE

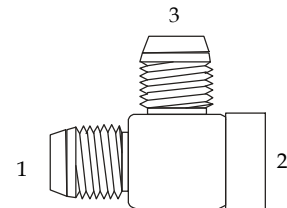

(1) (2) (3)	(1) MALE JIC	(2) FEMALE PIPE	(3) MALE JIC
2606-03-02-03	3/8 - 24	1/8" - 27	3/8 - 24
2606-04-02-04	7/16 - 20	1/8" - 27	7/16 - 20
2606-04-04-04	7/16 - 20	1/4" - 18	7/16 - 20
2606-06-04-06	9/16 - 18	1/4" - 18	9/16 - 18
2606-06-06-04	9/16 - 18	3/8" - 18	7/16 - 20
2606-06-06-06	9/16 - 18	3/8" - 18	9/16 - 18
2606-08-06-08	3/4 - 16	3/8" - 18	3/4 - 16
2606-08-08-08	3/4 - 16	1/2" - 14	3/4 - 16
2606-10-08-10	7/8 - 14	1/2" - 14	7/8 - 14
2606-12-12-12	1-1/16 - 12	3/4" - 14	1-1/16 - 12
2606-14-12-14	1-3/16 - 12	3/4" - 14	1-3/16 - 12
2606-16-16-16	1-5/16 - 12	1" - 11-1/2	1-5/16 - 12
2606-20-20-20	1-5/8 - 12	1-1/4" - 11-1/2	1-5/8 - 12
2606-24-24-24	1-7/8 - 12	1-1/2" - 11-1/2	1-7/8 - 12
2606-32-32-32	2-1/2 - 12	2" - 11-1/2	2-1/2 - 12

# JIC 37° FLARE ADAPTERS

## 2650 ...JIC MALE CROSS

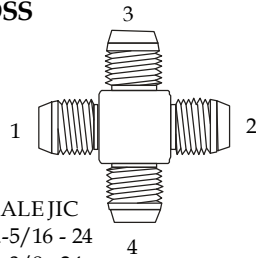

(1) (2) (3) (4)	MALE JIC
2650-02-02-02-02	02-5/16 - 24
2650-04-04-04-04	03-3/8 - 24
2650-05-05-05-05	04-7/16 - 20
2650-06-06-06-06	05-1/2 - 20
2650-06-08-06-08	06-9/16 - 18
2650-08-08-08-08	08-3/4 - 16
2650-10-10-10-10	10-7/8 - 14
2650-12-12-12-12	12-1-1/16 - 12
2650-14-14-14-14	14-1-3/16 - 12
2650-16-16-16-16	16-1-5/16 - 12
2650-20-20-20-20	20-1-5/8 - 12
2650-24-24-24-24	24-1-7/8 - 12
2650-32-32-32-32	32-2-1/2 - 12

## 2702 ...JIC BULKHEAD 45° ELBOW

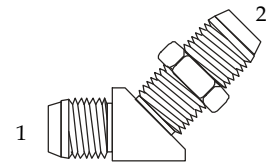

(1) (2)	MALE JIC	MALE JIC
2702-03-03	3/8 - 24	3/8 - 24
2702-04-04	7/16 - 20	7/16 - 20
2702-05-05	1/2 - 20	1/2 - 20
2702-06-06	9/16 - 18	9/16 - 18
2702-08-06	3/4 - 16	9/16 - 18
2702-08-08	3/4 - 16	3/4 - 16
2702-10-10	7/8 - 14	7/8 - 14
2702-12-12	1-1/16 - 12	1-1/16 - 12
2702-14-14	1-3/16 - 12	1-3/16 - 12
2702-16-16	1-5/16 - 12	1-5/16 - 12
2702-20-20	1-5/8 - 12	1-5/8 - 12
2702-24-24	1-7/8 - 12	1-7/8 - 12
2702-32-32	2-1/2 - 12	2-1/2 - 12

## 2700 ...JIC MALE BULKHEAD

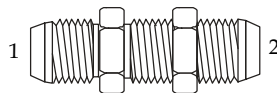

(1) (2)	MALE JIC	MALE JIC
2700-02-02	5/16 - 24	5/16 - 24
2700-03-03	3/8 - 24	3/8 - 24
2700-04-04	7/16 - 20	7/16 - 20
2700-05-05	1/2 - 20	1/2 - 20
2700-06-04	9/16 - 18	7/16 - 20
2700-06-06	9/16 - 18	9/16 - 18
2700-08-08	3/4 - 16	3/4 - 16
2700-10-10	7/8 - 14	7/8 - 14
2700-12-12	1-1/16 - 12	1-1/16 - 12
2700-14-14	1-3/16 - 12	1-3/16 - 12
2700-16-16	1-5/16 - 12	1-5/16 - 12
2700-20-20	1-5/8 - 12	1-5/8 - 12
2700-24-24	1-7/8 - 12	1-7/8 - 12
2700-32-32	2-1/2 - 12	2-1/2 - 12

## 2703 ...JIC BULKHEAD TEE

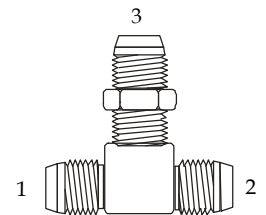

(1) (2) (3)	MALE JIC
2703-03-03-03	3/8 - 24
2703-04-04-04	7/16 - 20
2703-05-05-05	1/2 - 20
2703-06-06-06	9/16 - 18
2703-08-08-08	3/4 - 16
2703-10-10-10	7/8 - 14
2703-12-12-12	1-1/16 - 12
2703-16-16-16	1-5/16 - 12
2703-20-20-20	1-5/8 - 12
2703-24-24-24	1-7/8 - 12

## 2701 ...JIC BULKHEAD 90° ELBOW

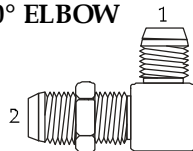

(1) (2)	MALE JIC	MALE JIC
2701-02-02	5/16 - 24	5/16 - 24
2701-03-03	3/8 - 24	3/8 - 24
2701-04-04	7/16 - 20	7/16 - 20
2701-05-05	1/2 - 20	1/2 - 20
2701-06-06	9/16 - 18	9/16 - 18
2701-08-08	3/4 - 16	3/4 - 16
2701-10-10	7/8 - 14	7/8 - 14
2701-12-12	1-1/16 - 12	1-1/16 - 12
2701-14-14	1-3/16 - 12	1-3/16 - 12
2701-16-16	1-5/16 - 12	1-5/16 - 12
2701-20-20	1-5/8 - 12	1-5/8 - 12
2701-24-24	1-7/8 - 12	1-7/8 - 12

# JIC 37° FLARE ADAPTERS

## 2704 ...JIC BULKHEAD TEE

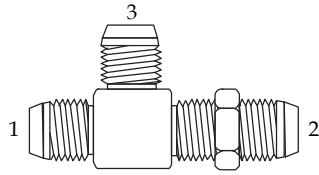

(1) (2) (3)	MALE JIC
2704-03-03-03	3/8 - 24
2704-04-04-04	7/16 - 20
2704-05-05-05	1/2 - 20
2704-06-06-06	9/16 - 18
2704-08-08-08	3/4 - 16
2704-10-10-10	7/8 - 14
2704-12-12-12	1-1/16 - 12
2704-16-16-16	1-5/16 - 12
2704-20-20-20	1-5/8 - 12

## 2705 ...JIC BULKHEAD - FEMALE PIPE

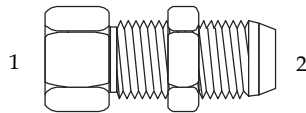

(1) (2)	FEMALE PIPE	MALE JIC
2705-02-04	1/8" - 27	7/16 - 20
2705-04-02	1/4" - 18	5/16 - 24
2705-04-04	1/4" - 18	7/16 - 20
2705-04-06	1/4" - 18	9/16 - 18
2705-06-04	3/8" - 18	7/16 - 20
2705-06-06	3/8" - 18	9/16 - 18
2705-06-08	3/8" - 18	3/4 - 16
2705-08-08	1/2" - 14	3/4 - 16
2705-08-10	1/2" - 14	7/8 - 14
2705-12-12	3/4" - 14	1-1/16 - 12
2705-12-14	3/4" - 14	1-3/16 - 12
2705-16-16	1" - 11-1/2	1-5/16 - 12
2705-20-20	1-1/4" - 11-1/2	1-5/8 - 12
2705-24-24	1-1/2" - 11-1/2	1-7/8 - 12

## 2706 ...JIC BULKHEAD - MALE PIPE

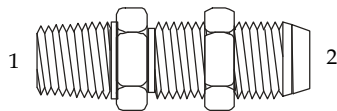

(1) (2)	MALE PIPE	MALE JIC
2706-02-04	1/8" - 27	7/16 - 20
2706-04-04	1/4" - 18	7/16 - 20
2706-04-06	1/4" - 18	9/16 - 18
2706-06-06	3/8" - 18	9/16 - 18
2706-06-08	3/8" - 18	3/4 - 16
2706-08-08	1/2" - 14	3/4 - 16
2706-08-10	1/2" - 14	3/4 - 16
2706-08-12	1/2" - 14	3/4 - 16
2706-12-12	3/4" - 14	1-1/16 - 12
2706-16-16	1" - 11-1/2	1-5/16 - 12
2706-20-20	1-1/4" - 11-1/2	1-5/8 - 12
2706-24-24	1-1/2" - 11-1/2	1-7/8 - 12
2706-32-32	2" - 11-1/2	2-1/2 - 12

## 6500 ...JIC SWIVEL 90° ELBOW

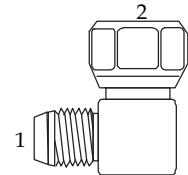

(1) (2)	MALE JIC	FEMALE JIC
6500-03-03	3/8 - 24	3/8 - 24
6500-04-04	7/16 - 20	7/16 - 20
6500-04-06	7/16 - 20	9/16 - 18
6500-05-05	1/2 - 20	1/2 - 20
6500-06-04	9/16 - 18	7/16 - 20
6500-06-06	9/16 - 18	9/16 - 18
6500-06-08	9/16 - 18	3/4 - 16
6500-08-06	3/4 - 16	9/16 - 18
6500-08-08	3/4 - 16	3/4 - 16
6500-08-10	3/4 - 16	7/8 - 14
6500-08-12	3/4 - 16	1-1/16 - 12
6500-10-08	7/8 - 14	3/4 - 16
6500-10-10	7/8 - 14	7/8 - 14
6500-10-12	7/8 - 14	1-1/16 - 12

6500-12-10	1-1/16 - 12	7/8 - 14
6500-12-12	1-1/16 - 12	1-1/16 - 12
6500-12-16	1-1/16 - 12	1-5/16 - 12
6500-14-14	1-3/16 - 12	1-3/16 - 12
6500-16-16	1-5/16 - 12	1-5/16 - 12
6500-20-20	1-5/8 - 12	1-5/8 - 12
6500-24-24	1-7/8 - 12	1-7/8 - 12
6500-32-32	2-1/2 - 12	2-1/2 - 12

## 6501 ...PIPE - JIC SWIVEL 90° ELBOW

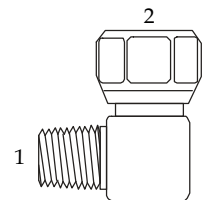

(1) (2)	MALE PIPE	FEMALE JIC
6501-02-04	1/8" - 27	7/16 - 20
6501-04-04	1/4" - 18	7/16 - 20
6501-04-06	1/4" - 18	9/16 - 18
6501-06-04	3/8" - 18	7/16 - 20
6501-06-06	3/8" - 18	9/16 - 18
6501-06-08	3/8" - 18	3/4 - 16
6501-08-06	1/2" - 14	9/16 - 18
6501-08-08	1/2" - 14	3/4 - 16
6501-08-10	1/2" - 14	7/8 - 14
6501-12-08	3/4" - 14	3/4 - 16
6501-12-12	3/4" - 14	1-1/16 - 12
6501-16-16	1" - 11-1/2	1-5/16 - 12
6501-20-20	1-1/4" - 11-1/2	1-5/8 - 12
6501-24-24	1-1/2" - 11-1/2	1-7/8 - 12
6501-32-32	2" - 11-1/2	2-1/2 - 12

# JIC 37° FLARE ADAPTERS

## 6502 ...JIC SWIVEL 45° ELBOW

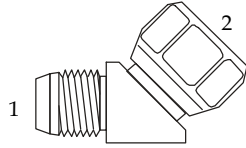

(1) (2)	MALE JIC	FEMALE JIC
6502-02-02	5/16 - 24	5/16 - 24
6502-04-04	7/16 - 20	7/16 - 20
6502-05-05	1/2 - 20	1/2 - 20
6502-06-06	9/16 - 18	9/16 - 18
6502-08-08	3/4 - 16	3/4 - 16
6502-10-08	7/8 - 14	3/4 - 16
6502-10-10	7/8 - 14	7/8 - 14
6502-12-12	1-1/16 - 12	1-1/16 - 12
6502-14-14	1-3/16 - 12	1-3/16 - 12
6502-16-16	1-5/16 - 12	1-5/16 - 12
6502-20-20	1-5/8 - 12	1-5/8 - 12
6502-24-24	1-7/8 - 12	1-7/8 - 12
6502-32-32	2-1/2 - 12	2-1/2 - 12

## 6503 ...FEMALE PIPE - JIC SWIVEL 90° ELBOW

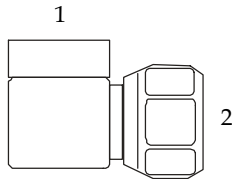

(1) (2)	FEMALE PIPE	FEMALE JIC
6503-04-04	1/4" - 18	7/16 - 20
6503-06-06	3/8" - 18	9/16 - 18
6503-08-08	1/2" - 14	3/4 - 16
6503-12-12	3/4" - 14	1-1/16 - 12
6503-16-16	1" - 11-1/2	1-5/16 - 12

## 6504 ...JIC SWIVEL CONNECTOR

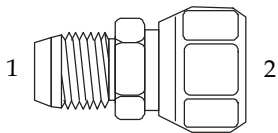

(1) (2)	MALE JIC	FEMALE JIC
6504-04-04	7/16-20	7/16-20
6504-04-06	7/16-20	9/16-18
6504-05-05	1/2-20	1/2-20
6504-06-04	9/16-18	7/16-20
6504-06-06	9/16-18	9/16-18
6504-06-08	9/16-18	3/4-16
6504-08-06	3/4-16	9/16-18
6504-08-08	3/4-16	3/4-16
6504-10-10	7/8-14	7/8-14
6504-12-12	1-1/16-12	1-1/16-12
6504-16-16	1-5/16-12	1-5/16-12
6504-20-20	1-5/8-12	1-5/8-12
6504-24-24	1-7/8-12	1-7/8-12

## 6505 ...JIC SWIVEL - PIPE

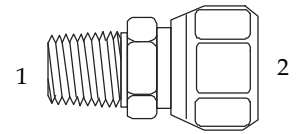

(1) (2)	MALE PIPE	FEMALE JIC
6505-02-04	1/8" - 27	7/16 - 20
6505-04-04	1/4" - 18	7/16 - 20
6505-04-05	1/4" - 18	1/2 - 20
6505-04-06	1/4" - 18	9/16 - 18
6505-06-04	3/8" - 18	7/16 - 20
6505-06-06	3/8" - 18	9/16 - 18
6505-06-08	3/8" - 18	3/4 - 16
6505-06-10	3/8" - 18	7/8 - 14
6505-08-06	1/2" - 14	9/16 - 18
6505-08-08	1/2" - 14	3/4 - 16
6505-08-10	1/2" - 14	7/8 - 14
6505-12-08	3/4" - 14	3/4 - 16
6505-12-10	3/4" - 14	7/8 - 14
6505-12-12	3/4" - 14	1-1/16 - 12
6505-12-16	3/4" - 14	1-5/16 - 12
6505-16-12	1" - 11-1/2	1-1/16 - 12
6505-16-16	1" - 11-1/2	1-5/16 - 12
6505-20-20	1-1/4" - 11-1/2	1-5/8 - 12
6505-24-24	1-1/2" - 11-1/2	1-7/8 - 12
6505-32-32	2" - 11-1/2	2-1/2 - 12

## 6506 ...FEMALE PIPE - JIC SWIVEL

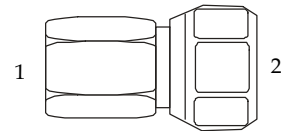

(1) (2)	FEMALE PIPE	FEMALE JIC
6506-04-02	1/4" - 18	5/16 - 24
6506-04-04	1/4" - 18	7/16 - 20
6506-04-06	1/4" - 18	9/16 - 18
6506-06-04	3/8" - 18	7/16 - 20
6506-06-06	3/8" - 18	9/16 - 18
6506-06-08	3/8" - 18	3/4 - 16
6506-06-10	3/8" - 18	7/8 - 14
6506-08-06	1/2" - 14	9/16 - 18
6506-08-08	1/2" - 14	3/4 - 16
6506-08-10	1/2" - 14	7/8 - 14
6506-12-10	3/4" - 14	7/8 - 14
6506-12-12	3/4" - 14	1-1/16 - 12
6506-16-16	1" - 11-1/2	1-5/16 - 12
6506-20-20	1-1/4" - 11-1/2	1-5/8 - 12
6506-24-24	1-1/2" - 11-1/2	1-7/8 - 12
6506-32-32	2" - 11-1/2	2-1/2 - 12



# JIC 37° FLARE ADAPTERS

## 6565 ...JIC SWIVEL CONNECTOR

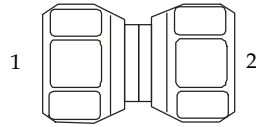

(1) (2)	FEMALE JIC	FEMALE JIC
6565-04-04	7/16 - 20	7/16 - 20
6565-06-06	9/16 - 18	9/16 - 18
6565-08-08	3/4 - 16	3/4 - 16
6565-10-10	7/8 - 14	7/8 - 14
6565-12-12	1-1/16 - 12	1-1/16 - 12
6565-16-16	1-5/16 - 12	1-5/16 - 12
6565-20-20	1-5/8 - 12	1-5/8 - 12

## 6600 ...JIC SWIVEL BRANCH TEE

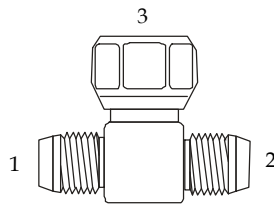

(1) (2) (3)	MALE JIC	FEMALE JIC
6600-03-03-03	3/8 - 24	3/8 - 24
6600-04-04-04	7/16 - 20	7/16 - 20
6600-05-05-05	1/2 - 20	1/2 - 20
6600-06-06-06	9/16 - 18	9/16 - 18
6600-06-06-08	9/16 - 18	3/4 - 16
6600-08-08-08	3/4 - 16	3/4 - 16
6600-10-10-10	7/8 - 14	7/8 - 14
6600-12-12-10	1-1/16 - 12	7/8 - 14
6600-12-12-12	1-1/16 - 12	1-1/16 - 12
6600-14-14-14	1-3/16 - 12	1-3/16 - 12
6600-16-16-16	1-5/16 - 12	1-5/16 - 12
6600-20-20-20	1-5/8 - 12	1-5/8 - 12
6600-24-24-24	1-7/8 - 12	1-7/8 - 12
6600-32-32-32	2-1/2 - 12	2-1/2 - 12

## 6602 ...JIC SWIVEL RUN TEE

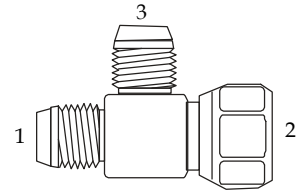

(1) (2) (3)	MALE JIC	FEMALE JIC	MALE JIC
6602-03-03-03	3/8 - 24	3/8 - 24	3/8 - 24
6602-04-04-04	7/16 - 20	7/16 - 20	7/16 - 20
6602-04-08-08	7/16 - 20	3/4 - 16	3/4 - 16
6602-05-05-05	1/2 - 20	1/2 - 20	1/2 - 20
6602-06-06-06	9/16 - 18	9/16 - 18	9/16 - 18
6602-08-06-08	3/4 - 16	9/16 - 18	3/4 - 16
6602-08-08-04	3/4 - 16	3/4 - 16	7/16 - 20
6602-08-08-08	3/4 - 16	3/4 - 16	3/4 - 16
6602-08-08-12	3/4 - 16	3/4 - 16	1-1/16 - 12
6602-10-10-08	7/8 - 14	7/8 - 14	3/4 - 16
6602-10-10-10	7/8 - 14	7/8 - 14	7/8 - 14
6602-10-10-12	7/8 - 14	7/8 - 14	1-1/16 - 12
6602-12-12-12	1-1/16 - 12	1-1/16 - 12	1-1/16 - 12
6602-14-14-14	1-3/16 - 12	1-3/16 - 12	1-3/16 - 12
6602-16-16-16	1-5/16 - 12	1-5/16 - 12	1-5/16 - 12
6602-20-20-20	1-5/8 - 12	1-5/8 - 12	1-5/8 - 12
6602-24-24-24	1-7/8 - 12	1-7/8 - 12	1-7/8 - 12
6602-32-32-32	2-1/2 - 12	2-1/2 - 12	2-1/2 - 12

## 6603 ...JIC SWIVEL - JIC MALE BRANCH TEE

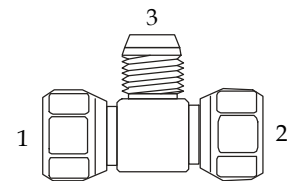

(1) (2) (3)	(1)(2) FEMALE JIC	(3) MALE JIC
6603-04-04-04	7/16 - 20	7/16 - 20
6603-06-06-06	9/16 - 18	9/16 - 18
6603-08-08-08	3/4 - 16	3/4 - 16
6603-10-10-10	7/8 - 14	7/8 - 14
6603-12-12-12	1-1/16 - 12	1-1/16 - 12
6603-16-16-16	1-5/16 - 12	1-5/16 - 12

# JIC 37° FLARE ADAPTERS

## 6606 ...JIC SWIVEL TEE

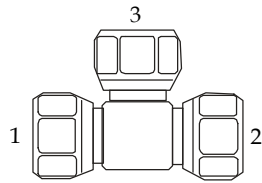

(1) (2) (3)	(1)(2)(3) FEMALE JIC
6606-04-04-04	7/16 - 20
6606-06-06-06	9/16 - 18
6606-08-08-08	3/4 - 16
6606-10-10-10	7/8 - 14
6606-12-12-12	1-1/16 - 12
6606-16-16-16	1-5/16 - 12

## 6801 ...JIC - ORB 90° ELBOW

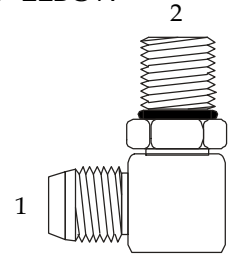

(1) (2)	MALE JIC	MALE ORB
6801-02-02	5/16 - 24	5/16 - 24
6801-02-04	5/16 - 24	7/16 - 20
6801-03-03	3/8 - 24	3/8 - 24
6801-03-04	3/8 - 24	7/16 - 20

6801-04-02	7/16 - 20	5/16 - 24
6801-04-03	7/16 - 20	3/8 - 24
6801-04-04	7/16 - 20	7/16 - 20
6801-04-05	7/16 - 20	1/2 - 20
6801-04-06	7/16 - 20	9/16 - 18
6801-04-08	7/16 - 20	3/4 - 16

6801-05-04	1/2 - 20	7/16 - 20
6801-05-05	1/2 - 20	1/2 - 20
6801-05-06	1/2 - 20	9/16 - 18
6801-05-08	1/2 - 20	3/4 - 16
6801-05-10	1/2 - 20	7/8 - 14

6801-06-04	9/16 - 18	7/16 - 20
6801-06-05	9/16 - 18	1/2 - 20
6801-06-06	9/16 - 18	9/16 - 18
6801-06-08	9/16 - 18	3/4 - 16
6801-06-10	9/16 - 18	7/8 - 14
6801-06-12	9/16 - 18	1-1/16 - 12

6801-08-04	3/4 - 16	7/16 - 20
6801-08-05	3/4 - 16	1/2 - 20
6801-08-06	3/4 - 16	9/16 - 18
6801-08-08	3/4 - 16	3/4 - 16
6801-08-10	3/4 - 16	7/8 - 14
6801-08-12	3/4 - 16	1-1/16 - 12
6801-08-16	3/4 - 16	1-5/16 - 12

6801-10-06	7/8 - 14	9/16 - 18
6801-10-08	7/8 - 14	3/4 - 16
6801-10-10	7/8 - 14	7/8 - 14
6801-10-12	7/8 - 14	1-1/16 - 12
6801-10-16	7/8 - 14	1-5/16 - 12
6801-10-20	7/8 - 14	1-5/8 - 16

6801-12-06	1-1/16 - 12	9/16 - 18
6801-12-08	1-1/16 - 12	3/4 - 16
6801-12-10	1-1/16 - 12	7/8 - 14
6801-12-12	1-1/16 - 12	1-1/16 - 12
6801-12-14	1-1/16 - 12	1-3/16 - 12
6801-12-16	1-1/16 - 12	1-5/16 - 12
6801-12-20	1-1/16 - 12	1-5/8 - 12

6801-14-12	1-3/16 - 12	1-1/16 - 12
6801-14-14	1-3/16 - 12	1-3/16 - 12
6801-14-16	1-3/16 - 12	1-5/16 - 12

...continued top of next page

## 6701 ...JIC SWIVEL BENT TUBE ELBOW 90°

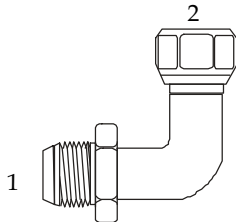

(1) (2)	MALE JIC	FEMALE JIC
6701-04-04	7/16 - 20	7/16 - 20
6701-06-06	9/16 - 18	9/16 - 18
6701-08-08	3/4 - 16	3/4 - 16
6701-10-10	7/8 - 14	7/8 - 14
6701-12-12	1-1/16 - 12	1-1/16 - 12
6701-16-16	1-5/16 - 12	1-5/16 - 12
6701-20-20	1-5/8 - 12	1-5/8 - 12

## 6701 ...JIC SWIVEL BENT TUBE ELBOW 90° LONG

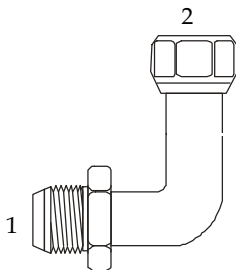

(1) (2)	MALE JIC	FEMALE JIC
6701L-04-04	7/16 - 20	7/16 - 20
6701L-06-06	9/16 - 18	9/16 - 18
6701L-08-08	3/4 - 16	3/4 - 16
6701L-10-10	7/8 - 14	7/8 - 14
6701L-12-12	1-1/16 - 12	1-1/16 - 12
6701L-16-16	1-5/16 - 12	1-5/16 - 12
6701L-20-20	1-5/8 - 12	1-5/8 - 12

# JIC 37° FLARE ADAPTERS

...continued from previous page

(1) (2)	MALE JIC	MALE ORB
6801-16-08	1-5/16 - 12	3/4 - 16
6801-16-10	1-5/16 - 12	7/8 - 14
6801-16-12	1-5/16 - 12	1-1/16 - 12
6801-16-14	1-5/16 - 12	1-3/16 - 12
6801-16-16	1-5/16 - 12	1-5/16 - 12
6801-16-20	1-5/16 - 12	1-5/8 - 12
6801-16-24	1-5/16 - 12	1-7/8 - 12
6801-20-12	1-5/8 - 12	1-1/16 - 12
6801-20-14	1-5/8 - 12	1-3/16 - 12
6801-20-16	1-5/8 - 12	1-5/16 - 12
6801-20-20	1-5/8 - 12	1-5/8 - 12
6801-20-24	1-5/8 - 12	1-7/8 - 12
6801-24-16	1-7/8 - 12	1-5/16 - 12
6801-24-20	1-7/8 - 12	1-5/8 - 12
6801-24-24	1-7/8 - 12	1-7/8 - 12
6801-24-32	1-7/8 - 12	2-1/2 - 12
6801-32-24	2-1/2 - 12	1-7/8 - 12
6801-32-32	2-1/2 - 12	2-1/2 - 12

## 6801L ...JIC - ORB 90° LONG ELBOW

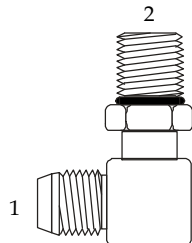

(1) (2)	MALE JIC	MALE ORB
6801-L-04-04	7/16 - 20	7/16 - 20
6801-L-06-06	9/16 - 18	9/16 - 18
6801-L-06-08	9/16 - 18	3/4 - 16
6801-L-08-06	3/4 - 16	9/16 - 18
6801-L-08-08	3/4 - 16	3/4 - 16
6801-L-08-10	3/4 - 16	7/8 - 14
6801-L-10-08	7/8 - 14	3/4 - 16
6801-L-10-10	7/8 - 14	7/8 - 14
6801-L-10-12	7/8 - 14	1-1/16 - 12
6801-L-12-10	1-1/16 - 12	7/8 - 14
6801-L-12-12	1-1/16 - 12	1-1/16 - 12
6801-L-16-12	1-5/16 - 12	1-1/16 - 12
6801-L-16-16	1-5/16 - 12	1-5/16 - 12
6801-L-20-20	1-5/8 - 12	1-5/8 - 12

## 6801LL ...JIC - ORB 90° X LONG ELBOW

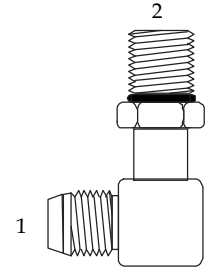

(1) (2)	MALE JIC	MALE ORB
6801-LL-04-04	7/16 - 20	7/16 - 20
6801-LL-04-06	7/16 - 20	9/16 - 18
6801-LL-06-06	9/16 - 18	9/16 - 18
6801-LL-06-08	9/16 - 18	3/4 - 16
6801-LL-08-06	3/4 - 16	9/16 - 18
6801-LL-08-08	3/4 - 16	3/4 - 16
6801-LL-08-10	3/4 - 16	7/8 - 14
6801-LL-10-08	7/8 - 14	3/4 - 16
6801-LL-10-10	7/8 - 14	7/8 - 14
6801-LL-12-12	1-1/16 - 12	1-1/16 - 12
6801-LL-12-16	1-1/16 - 12	1-5/16 - 12
6801-LL-16-12	1-5/16 - 12	1-1/16 - 12
6801-LL-16-16	1-5/16 - 12	1-5/16 - 12
6801-LL-20-20	1-5/8 - 12	1-5/8 - 12

## 6801LLL ...JIC - ORB 90° XX LONG ELBOW

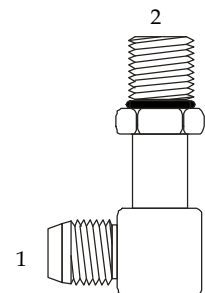

(1) (2)	MALE JIC	MALE ORB
6801-LLL-04-04	7/16 - 20	7/16 - 20
6801-LLL-06-06	9/16 - 18	9/16 - 18
6801-LLL-06-08	9/16 - 18	9/16 - 18
6801-LLL-08-08	3/4 - 16	3/4 - 16
6801-LLL-10-10	7/8 - 14	7/8 - 14
6801-LLL-12-12	1-1/16 - 12	1-1/16 - 12
6801-LLL-16-16	1-5/16 - 12	1-5/16 - 12

# JIC 37° FLARE ADAPTERS

## 6802 ...JIC to ORB 45° ELBOW

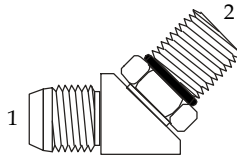

(1) (2)	MALE JIC	MALE ORB
6802-02-02	5/16-24	5/16-24
6802-04-04	7/16-20	7/16-20
6802-04-05	7/16-20	1/2-20
6802-04-06	7/16-20	9/16-18
6802-04-08	7/16-20	3/4-16
6802-05-04	1/2-20	7/16-20
6802-05-05	1/2-20	1/2-20
6802-05-06	1/2-20	9/16-18
6802-06-04	9/16-18	7/16-20
6802-06-05	9/16-18	1/2-20
6802-06-06	9/16-18	9/16-18
6802-06-08	9/16-18	3/4-16
6802-06-10	9/16-18	7/8-14
6802-08-04	3/4-16	7/16-20
6802-08-06	3/4-16	9/16-18
6802-08-08	3/4-16	3/4-16
6802-08-10	3/4-16	7/8-14
6802-08-12	3/4-16	1-1/16-12
6802-10-08	7/8-14	3/4-16
6802-10-10	7/8-14	7/8-14
6802-10-12	7/8-14	1-1/16-12
6802-12-08	1-1/16-12	3/4-16
6802-12-10	1-1/16-12	7/8-14
6802-12-12	1-1/16-12	1-1/16-12
6802-12-16	1-1/16-12	1-5/16-12
6802-16-12	1-5/16-12	1-1/16-12
6802-16-16	1-5/16-12	1-5/16-12
6802-16-20	1-5/16-12	1-5/8-12
6802-20-16	1-5/8-12	1-5/16-12
6802-20-20	1-5/8-12	1-5/8-12
6802-20-24	1-5/8-12	1-7/8-12
6802-24-20	1-7/8-12	1-5/8-12
6802-24-24	1-7/8-12	1-7/8-12
6802-32-32	2-1/2-12	2-1/2-12

## 6803 ... JIC to ORB BRANCH TEE

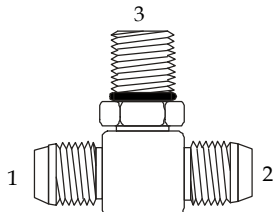

(1) (2) (3)	(1) (2) MALE JIC	(3) MALE ORB
6803-04-04-04	7/16-20	7/16-20
6803-04-04-06	7/16-20	9/16-18
6803-05-05-05	1/2-20	1/2-20
6803-06-06-04	9/16-18	7/16-20
6803-06-06-06	9/16-18	9/16-18
6803-06-06-08	9/16-18	3/4-16

...continued top of next page

...continued

6803-08-08-06	3/4-16	9/16-18
6803-08-08-08	3/4-16	3/4-16
6803-08-08-10	3/4-16	7/8-14
6803-10-10-08	7/8-14	3/4-16
6803-10-10-10	7/8-14	7/8-14
6803-10-10-12	7/8-14	1-1/16-12
6803-12-12-08	1-1/16-12	3/4-16
6803-12-12-10	1-1/16-12	7/8-14
6803-12-12-12	1-1/16-12	1-1/16-12
6803-12-12-16	1-1/16-12	1-5/16-12
6803-14-14-14	1-3/16-12	1-3/16-12
6803-16-16-12	1-5/16-12	1-1/16-12
6803-16-16-16	1-5/16-12	1-5/16-12
6803-20-20-20	1-5/8-12	1-5/8-12
6803-24-24-24	1-7/8-12	1-7/8-12
6803-32-32-32	2-1/2-12	2-1/2-12

## 6804 ...JIC to ORB RUN TEE

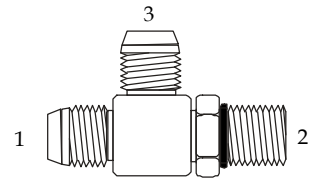

(1) (2) (3)	(1) MALE JIC	(2) MALE ORB	(3) MALE JIC
6804-04-04-04	7/16-20	7/16-20	7/16-20
6804-04-06-04	7/16-20	9/16-18	7/16-20
6804-04-06-06	7/16-20	9/16-18	9/16-18
6804-05-05-05	1/2-20	1/2-20	1/2-20
6804-06-04-06	9/16-18	7/16-20	9/16-18
6804-06-06-04	9/16-18	9/16-18	7/16-20
6804-06-06-06	9/16-18	9/16-18	9/16-18
6804-06-06-08	9/16-18	9/16-18	3/4-16
6804-06-08-06	9/16-18	3/4-16	9/16-18
6804-08-06-08	3/4-16	9/16-18	3/4-16
6804-08-08-08	3/4-16	3/4-16	3/4-16
6804-08-10-08	3/4-16	7/8-14	3/4-16
6804-08-12-08	3/4-16	1-1/16-12	3/4-16
6804-10-08-10	7/8-14	3/4-16	7/8-14
6804-10-10-10	7/8-14	7/8-14	7/8-14
6804-10-10-12	7/8-14	7/8-14	1-1/16-12
6804-10-12-10	7/8-14	1-1/16-12	7/8-14
6804-12-10-12	1-1/16-12	7/8-14	1-1/16-12
6804-12-12-12	1-1/16-12	1-1/16-12	1-1/16-12
6804-12-12-16	1-1/16-12	1-1/16-12	1-5/16-12
6804-14-14-14	1-3/16-12	1-3/16-12	1-3/16-12
6804-16-12-16	1-5/16-12	1-1/16-12	1-5/16-12
6804-16-16-16	1-5/16-12	1-5/16-12	1-5/16-12
6804-20-20-20	1-5/8-12	1-5/8-12	1-5/8-12
6804-24-24-24	1-7/8-12	1-7/8-12	1-7/8-12
6804-32-32-32	2-1/2-12	2-1/2-12	2-1/2-12

# JIC 37° FLARE ADAPTERS

## 6805 ...ORB to PIPE 90° ELBOW

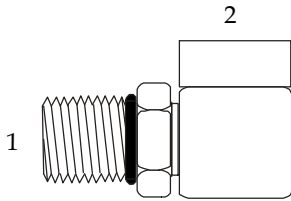

(1) (2)	MALE ORB	FEMALE PIPE
6805-02-04	5/16 - 24	1/4" - 18
6805-04-02	7/16 - 20	1/8" - 27
6805-04-04	7/16 - 20	1/4" - 18
6805-05-02	1/2 - 20	1/8" - 27
6805-06-04	9/16 - 18	1/4" - 18
6805-06-06	9/16 - 18	3/8" - 18
6805-08-06	3/4 - 16	3/8" - 18
6805-08-08	3/4 - 16	1/2" - 14
6805-10-06	7/8 - 14	3/8" - 18
6805-10-08	7/8 - 14	1/2" - 14
6805-12-08	1-1/16 - 12	1/2" - 14
6805-12-12	1-1/16 - 12	3/4" - 14
6805-16-12	1-5/16 - 12	3/4" - 14
6805-16-16	1-5/16 - 12	1" - 11-1/2
6805-20-20	1-5/8 - 12	1-1/4" - 11-1/2
6805-24-24	1-7/8 - 12	1-1/2" - 11-1/2
6805-32-32	2-1/2 - 12	2" - 11-1/2

## 6806 ...ORB to PIPE CONNECTOR

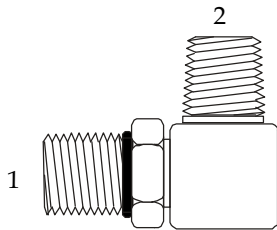

(1) (2)	MALE ORB	MALE PIPE
6806-04-02	7/16 - 20	1/8" - 27
6806-04-04	7/16 - 20	1/4" - 18
6806-05-02	1/2 - 20	1/8" - 27
6806-06-04	9/16 - 18	1/4" - 18
6806-06-06	9/16 - 18	3/8" - 18
6806-08-06	3/4 - 16	3/8" - 18
6806-08-08	3/4 - 16	1/2" - 14
6806-10-08	7/8 - 14	1/2" - 14
6806-12-12	1-1/16 - 12	3/4" - 14
6806-12-16	1-1/16 - 12	1" - 11-1/2
6806-14-12	1-3/16 - 12	3/4" - 14
6806-16-12	1-5/16 - 12	3/4" - 14
6806-16-16	1-5/16 - 12	1" - 11-1/2
6806-20-20	1-5/8 - 12	1-1/4" - 11-1/2
6806-24-24	1-7/8 - 12	1-1/2" - 11-1/2
6806-32-32	2-1/2 - 12	2" - 11-1/2

## 6807 ... ORB 90° ELBOW

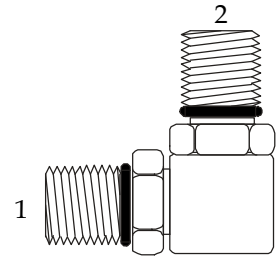

(1) (2)	(1) MALE ORB	(2) MALE ORB
6807-04-04	7/16 - 20	7/16 - 20
6807-06-06	9/16 - 18	9/16 - 18
6807-08-08	3/4 - 16	3/4 - 16
6807-10-10	7/8 - 14	7/8 - 14
6807-12-12	1-1/16 - 12	1-1/16 - 12
6807-16-16	1-5/16 - 12	1-5/16 - 12

## 6809 ... ORB to JIC SWIVEL 90° ELBOW

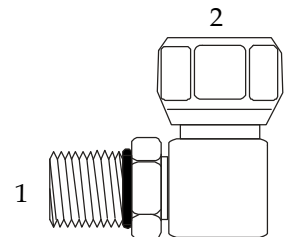

(1) (2)	MALE ORB	FEMALE JIC
6809-04-04	7/16 - 20	7/16 - 20
6809-06-04	9/16 - 18	7/16 - 20
6809-06-06	9/16 - 18	9/16 - 18
6809-08-06	3/4 - 16	9/16 - 18
6809-08-08	3/4 - 16	3/4 - 16
6809-10-10	7/8 - 14	7/8 - 14
6809-12-08	1-1/16 - 12	3/4 - 16
6809-12-12	1-1/16 - 12	1-1/16 - 12
6809-16-16	1-5/16 - 12	1-5/16 - 12
6809-20-20	1-5/8 - 12	1-5/8 - 12
6809-24-24	1-7/8 - 12	1-7/8 - 12

# O-RING BOSS ADAPTERS

Detailed Sizes on the following pages.

**3474**



(1)(2) Male ORB Bulkhead

**6400**

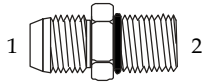

(1) Male JIC  
(2) Male ORB

**6400-L**

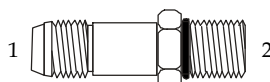

(1) Male JIC  
(2) Male ORB LONG

**6401**

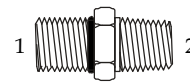

(1) Male ORB  
(2) Male NPT

**6402**

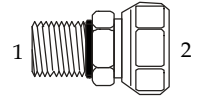

(1) Male ORB  
(2) Female JIC

**6404**

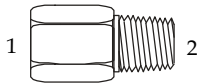

(1) Female ORB  
(2) Male NPT

**6405**

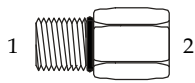

(1) Male ORB  
(2) Female NPT

**6408**

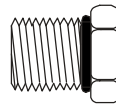

ORB Plug

**6408-H**

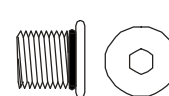

ORB Sunken Hex Plug

**6410**

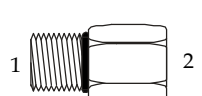

(1) Male ORB  
(2) Female ORB

**6801**

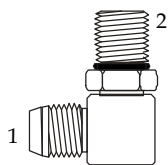

(1) Male JIC  
(2) Male ORB

**6801-L**

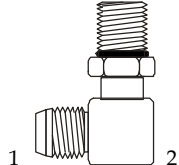

(1) Male JIC  
(2) Male ORB Long

**6801-LL**

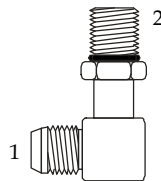

(1) Male JIC  
(2) Male ORB X Long

**6801-LLL**

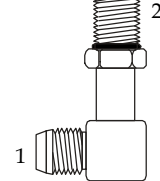

(1) Male JIC  
(2) Male ORB XX Long

**6802**

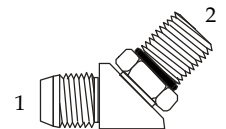

(1) Male JIC  
(2) Male ORB

**6803**

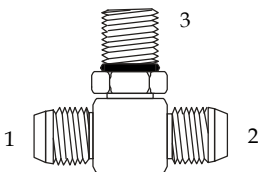

(1)(2) Male JIC  
(3) Male ORB

**6804**

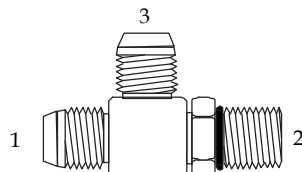

(1)(3) Male JIC  
(2) Male ORB

**6805**

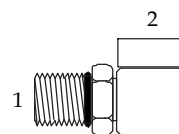

(1) Male ORB  
(2) Female NPT

**6806**

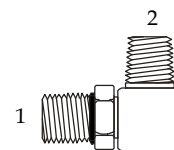

(1) Male ORB  
(2) Male NPT

**6807**

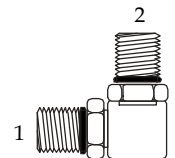

(1)(2) Male ORB

**6808**

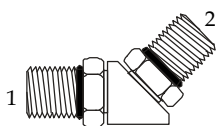

(1)(2) Male ORB

**6809**

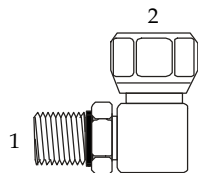

(1) Male ORB  
(2) Female JIC SWIVEL

**6900**

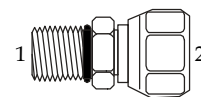

(1) Male ORB  
(2) Female NPT

**6901**

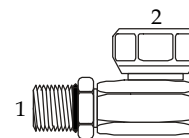

(1) Male ORB  
(2) Female NPT

**6902**

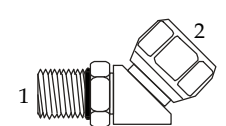

(1) Male ORB  
(2) Female NPT

# O-RING BOSS ADAPTERS

## 3474 ...O-RING MALE ADJUSTABLE UNION

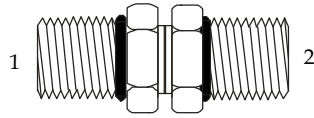

(1) (2)	(1) (2) MALE ORB
3474-04-04	7/16 - 20
3474-06-06	9/16 - 18
3474-08-08	3/4 - 16
3474-10-10	7/8 - 14
3474-12-12	1-1/16 - 12
3474-16-16	1-5/16 - 12
3474-20-20	1-5/8 - 12
3474-24-24	1-7/8 - 12
3474-32-32	2-1/2 - 12

## 6400 ...JIC - O-RING CONNECTOR

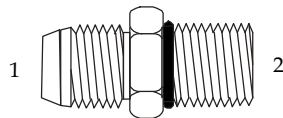

(1) (2)	MALE JIC	MALE ORB
6400-02-02	5/16 - 24	5/16 - 24
6400-03-03	3/8 - 24	3/8 - 24
6400-04-02	7/16 - 20	5/16 - 24
6400-04-03	7/16 - 20	3/8 - 24
6400-04-04	7/16 - 20	7/16 - 20
6400-04-05	7/16 - 20	1/2 - 20
6400-04-06	7/16 - 20	9/16 - 18
6400-04-08	7/16 - 20	3/4 - 16
6400-04-10	7/16 - 20	7/8 - 14
6400-04-12	7/16 - 20	1-1/16 - 12
6400-05-04	1/2 - 20	7/16 - 20
6400-05-05	1/2 - 20	1/2 - 20
6400-05-06	1/2 - 20	9/16 - 18
6400-05-08	1/2 - 20	3/4 - 16
6400-05-10	1/2 - 20	7/8 - 14
6400-06-04	9/16 - 18	7/16 - 20
6400-06-05	9/16 - 18	1/2 - 20
6400-06-06	9/16 - 18	9/16 - 18
6400-06-08	9/16 - 18	3/4 - 16
6400-06-10	9/16 - 18	7/8 - 14
6400-06-12	9/16 - 18	1-1/16 - 12
6400-06-16	9/16 - 18	1-5/16 - 12
6400-08-04	3/4 - 16	7/16 - 20
6400-08-05	3/4 - 16	1/2 - 20
6400-08-06	3/4 - 16	9/16 - 18
6400-08-08	3/4 - 16	3/4 - 16
6400-08-10	3/4 - 16	7/8 - 14
6400-08-12	3/4 - 16	1-1/16 - 12
6400-08-16	3/4 - 16	1-5/16 - 12

...continued

(1) (2)	MALE JIC	MALE ORB
6400-10-04	7/8 - 14	7/16 - 20
6400-10-06	7/8 - 14	9/16 - 18
6400-10-08	7/8 - 14	3/4 - 16
6400-10-10	7/8 - 14	7/8 - 14
6400-10-12	7/8 - 14	1-1/16 - 12
6400-10-16	7/8 - 14	1-5/16 - 12
6400-10-20	7/8 - 14	1-5/8 - 16
6400-12-06	1-1/16 - 12	9/16 - 18
6400-12-08	1-1/16 - 12	3/4 - 16
6400-12-10	1-1/16 - 12	7/8 - 14
6400-12-12	1-1/16 - 12	1-1/16 - 12
6400-12-14	1-1/16 - 12	1-3/16 - 12
6400-12-16	1-1/16 - 12	1-5/16 - 12
6400-12-20	1-1/16 - 12	1-5/8 - 16
6400-12-24	1-1/16 - 12	1-7/8 - 12
6400-14-08	1-3/16 - 12	3/4 - 16
6400-14-10	1-3/16 - 12	7/8 - 14
6400-14-12	1-3/16 - 12	1-1/16 - 12
6400-14-14	1-3/16 - 12	1-3/16 - 12
6400-14-16	1-3/16 - 12	1-5/16 - 12
6400-16-08	1-5/16 - 12	3/4 - 16
6400-16-10	1-5/16 - 12	7/8 - 14
6400-16-12	1-5/16 - 12	1-1/16 - 12
6400-16-14	1-5/16 - 12	1-3/16 - 12
6400-16-16	1-5/16 - 12	1-5/16 - 12
6400-16-20	1-5/16 - 12	1-5/8 - 12
6400-16-24	1-5/16 - 12	1-7/8 - 12
6400-20-12	1-5/8 - 12	1-1/16 - 12
6400-20-16	1-5/8 - 12	1-5/16 - 12
6400-20-20	1-5/8 - 12	1-5/8 - 12
6400-20-24	1-5/8 - 12	1-7/8 - 12
6400-24-16	1-7/8 - 12	1-5/16 - 12
6400-24-20	1-7/8 - 12	1-5/8 - 12
6400-24-24	1-7/8 - 12	1-7/8 - 12
6400-24-32	2-1/2 - 12	2-1/2 - 12
6400-32-24	1-7/8 - 12	1-7/8 - 12
6400-32-32	2-1/2 - 12	2-1/2 - 12

## ORB ... O-RING BOSS (ORB) O-RINGS

	O-RING I.D.	O-RING ID.
ORB-2	.239"	924"
ORB-3	.301"	1.048"
ORB-4	.351"	1.171"
ORB-5	.414"	1.475"
ORB-6	.468"	1.720"
ORB-8	.644"	2.337"
ORB-10	.755"	

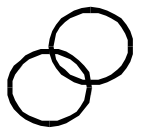

...continued top of next column

# O-RING BOSS ADAPTERS

## 6400L ...JIC - ORB LONG CONNECTOR

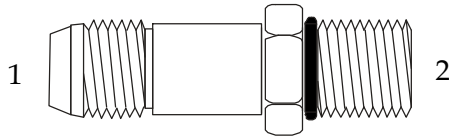

(1) (2)	MALE JIC	MALE ORB
6400-L-04-04	7/16 - 20	7/16 - 20
6400-L-05-05	1/2 - 20	1/2 - 20
6400-L-06-06	9/16 - 18	9/16 - 18
6400-L-08-08	3/4 - 16	3/4 - 16
6400-L-10-10	7/8 - 14	7/8 - 14
6400-L-12-12	1-1/16 - 12	1-1/16 - 12
6400-L-16-16	1-5/16 - 12	1-5/16 - 12
6400-L-20-20	1-5/8 - 12	1-5/8 - 12

## 6402 ...MALE ORB - FEMALE JIC SWIVEL

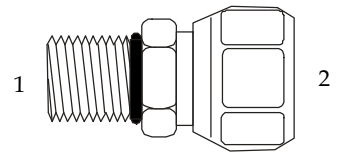

(1) (2)	MALE ORB	FEMALE JIC
6402-04-04	7/16 - 20	7/16 - 20
6402-06-06	9/16 - 18	9/16 - 18
6402-08-08	3/4 - 16	3/4 - 16
6402-10-10	7/8 - 14	7/8 - 14
6402-12-12	1-1/16 - 12	1-1/16 - 12
6402-16-16	1-5/16 - 12	1-5/16 - 12
6402-20-20	1-5/8 - 12	1-5/8 - 12

## 6401 ...ORB - PIPE CONNECTOR

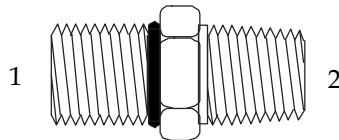

(1) (2)	MALE ORB	MALE PIPE
6401-04-02	7/16 - 20	1/8" - 27
6401-04-04	7/16 - 20	1/4" - 18
6401-04-06	7/16 - 20	3/8" - 18
6401-05-02	1/2 - 20	1/8" - 27
6401-05-04	1/2 - 20	1/4" - 18
6401-06-02	9/16 - 18	1/8" - 27
6401-06-04	9/16 - 18	1/4" - 18
6401-06-06	9/16 - 18	3/8" - 18
6401-06-08	9/16 - 18	1/2" - 14
6401-08-04	3/4 - 16	1/4" - 18
6401-08-06	3/4 - 16	3/8" - 18
6401-08-08	3/4 - 16	1/2" - 14
6401-08-12	3/4 - 16	3/4" - 14
6401-10-04	7/8 - 14	1/4" - 18
6401-10-06	7/8 - 14	3/8" - 18
6401-10-08	7/8 - 14	1/2" - 14
6401-10-12	7/8 - 14	3/4" - 14
6401-12-06	1-1/16 - 12	3/8" - 18
6401-12-08	1-1/16 - 12	1/2" - 14
6401-12-12	1-1/16 - 12	3/4" - 14
6401-12-16	1-1/16 - 12	1" - 11-1/2
6401-16-12	1-5/16 - 12	3/4" - 14
6401-16-16	1-5/16 - 12	1" - 11-1/2
6401-16-20	1-5/16 - 12	1-1/4" - 11-1/2
6401-20-12	1-5/8 - 12	3/4" - 14
6401-20-16	1-5/8 - 12	1" - 11-1/2
6401-20-20	1-5/8 - 12	1-1/4" - 11-1/2
6401-24-16	1-7/8 - 12	1" - 11-1/2
6401-24-20	1-7/8 - 12	1-1/4" - 11-1/2
6401-24-24	1-7/8 - 12	1-1/2" - 11-1/2
	2-1/2 - 12	2" - 11-1/2

## 6404 ...FEMALE ORB - PIPE CONNECTOR

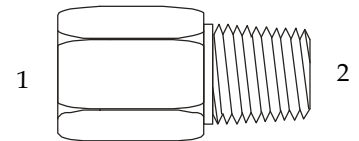

(1) (2)	FEMALE ORB	MALE PIPE
6404-04-02	7/16 - 20	1/8" - 27
6404-04-04	7/16 - 20	1/4" - 18
6404-04-06	7/16 - 20	3/8" - 18
6404-05-02	1/2 - 20	1/8" - 27
6404-05-04	1/2 - 20	1/4" - 18
6404-06-04	9/16 - 18	1/4" - 18
6404-06-06	9/16 - 18	3/8" - 18
6404-06-08	9/16 - 18	1/2" - 14
6404-08-04	3/4 - 16	1/4" - 18
6404-08-06	3/4 - 16	3/8" - 18
6404-08-08	3/4 - 16	1/2" - 14
6404-08-12	3/4 - 16	3/4" - 14
6404-10-06	7/8 - 14	3/8" - 18
6404-10-08	7/8 - 14	1/2" - 14
6404-10-12	7/8 - 14	3/4" - 14
6404-12-08	1-1/16 - 12	1/2" - 14
6404-12-12	1-1/16 - 12	3/4" - 14
6404-14-12	1-3/16 - 12	3/4" - 14
6404-16-12	1-5/16 - 12	3/4" - 14
6404-16-16	1-5/16 - 12	1" - 11-1/2
6404-20-20	1-5/8 - 12	1-1/4" - 11-1/2
6404-24-24	1-7/8 - 12	1-1/2" - 11-1/2
	2-1/2 - 12	2" - 11-1/2



# O-RING BOSS ADAPTERS

## 6405 ...ORB - FEMALE PIPE CONNECTOR

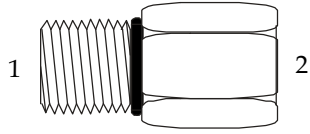

(1) (2)	MALE ORB	FEMALE PIPE
6405-02-02	5/16 - 24	1/8" - 27
6405-02-04	5/16 - 24	1/4" - 18
6405-03-04	3/8 - 24	1/4" - 18
6405-04-02	7/16 - 20	1/8" - 27
6405-04-04	7/16 - 20	1/4" - 18
6405-04-06	7/16 - 20	3/8" - 18
6405-05-02	1/2 - 20	1/8" - 27
6405-05-04	1/2 - 20	1/4" - 18
6405-05-06	1/2 - 20	3/8" - 18
6405-06-02	9/16 - 18	1/8" - 27
6405-06-04	9/16 - 18	1/4" - 18
6405-06-06	9/16 - 18	3/8" - 18
6405-06-08	9/16 - 18	1/2" - 14
6405-08-02	3/4 - 16	1/8" - 27
6405-08-04	3/4 - 16	1/4" - 18
6405-08-06	3/4 - 16	3/8" - 18
6405-08-08	3/4 - 16	1/2" - 14
6405-08-12	3/4 - 16	3/4" - 14
6405-10-04	7/8 - 14	1/4" - 18
6405-10-06	7/8 - 14	3/8" - 18
6405-10-08	7/8 - 14	1/2" - 14
6405-10-12	7/8 - 14	3/4" - 14
6405-12-04	1-1/16 - 12	1/4" - 18
6405-12-06	1-1/16 - 12	3/8" - 18
6405-12-08	1-1/16 - 12	1/2" - 14
6405-12-12	1-1/16 - 12	3/4" - 14
6405-12-16	1-1/16 - 12	1" - 11-1/2
6405-14-12	1-3/16 - 12	3/4" - 14
6405-14-16	1-3/16 - 12	1" - 11-1/2
6405-16-04	1-5/16 - 12	1/4" - 18
6405-16-06	1-5/16 - 12	3/8" - 18
6405-16-08	1-5/16 - 12	1/2" - 14
6405-16-12	1-5/16 - 12	3/4" - 14
6405-16-16	1-5/16 - 12	1" - 11-1/2
6405-16-20	1-5/16 - 12	1-1/4" - 11-1/2
6405-16-24	1-5/16 - 12	1-1/2" - 11-1/2
6405-20-08	1-5/8 - 12	1/2" - 14
6405-20-12	1-5/8 - 12	3/4" - 14
6405-20-16	1-5/8 - 12	1" - 11-1/2
6405-20-20	1-5/8 - 12	1-1/4" - 11-1/2
6405-20-24	1-5/8 - 12	1-1/2" - 11-1/2
6405-20-32	1-5/8 - 12	2" - 11-1/2
6405-24-12	1-7/8 - 12	3/4" - 14
6405-24-16	1-7/8 - 12	1" - 11-1/2
6405-24-20	1-7/8 - 12	1-1/4" - 11-1/2
6405-24-24	1-7/8 - 12	1-1/2" - 11-1/2
6405-32-16	2-1/2 - 12	1" - 11-1/2
6405-32-20	2-1/2 - 12	1-1/4" - 11-1/2
6405-32-24	2-1/2 - 12	1-1/2" - 11-1/2
6405-32-32	2-1/2 - 12	2" - 11-1/2

## 6408 ...O-RING HEX PLUG

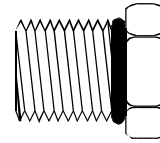

	MALE ORB
6408-02	5/16 - 24
6408-03	3/8 - 24
6408-04	7/16 - 20
6408-05	1/2 - 20
6408-06	9/16 - 18
6408-08	3/4 - 16
6408-10	7/8 - 14
6408-12	1-1/16 - 12
6408-14	1-3/16 - 12
6408-16	1-5/16 - 12
6408-20	1-5/8 - 12
6408-24	1-7/8 - 12
6408-32	2-1/2 - 12

## 6408H ...O-RING HOLLOW HEX PLUG

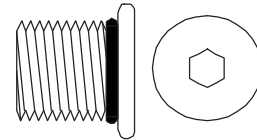

	MALE ORB
6408-HHP-02	5/16 - 24
6408-HHP-03	3/8 - 24
6408-HHP-04	7/16 - 20
6408-HHP-05	1/2 - 20
6408-HHP-06	9/16 - 18
6408-HHP-08	3/4 - 16
6408-HHP-10	7/8 - 14
6408-HHP-12	1-1/16 - 12
6408-HHP-14	1-3/16 - 12
6408-HHP-16	1-5/16 - 12
6408-HHP-20	1-5/8 - 12
6408-HHP-24	1-7/8 - 12
6408-HHP-32	2-1/2 - 12

# O-RING BOSS ADAPTERS

## 6410 ...ORB REDUCER/ EXPANDER

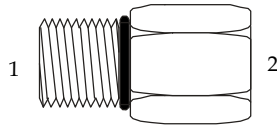

(1) (2)	MALE ORB	FEMALE ORB
6410-02-04	5/16 -24	7/16 -20
6410-03-04	3/8 - 24	7/16 -20
6410-04-03	7/16 -20	3/8 -24
6410-04-04	7/16 -20	7/16 -20
6410-04-05	7/16 -20	1/2 -20
6410-04-06	7/16 -20	9/16 -18
6410-04-08	7/16 -20	3/4 -16
6410-05-04	1/2 -20	7/16 -20
6410-05-06	1/2 -20	9/16 -18
6410-06-04	9/16 -18	7/16 -20
6410-06-06	9/16 -18	9/16 -18
6410-06-08	9/16 -18	3/4 -16
6410-08-04	3/4 -16	7-16 -20
6410-08-06	3/4 -16	9/16 -18
6410-08-08	3/4 -16	3/4 -16
6410-08-10	3/4 -16	7/8 -14
6410-08-12	3/4 -16	1-1/16 -12
6410-10-04	7/8 -14	7/16 -20
6410-10-05	7/8 -14	1/2 -20
6410-10-06	7/8 -14	9/16 -18
6410-10-08	7/8 -14	3/4 -16
6410-10-12	7/8 -14	1-1/16 -12
6410-12-04	1-1/16 -12	7/16 -20
6410-12-06	1-1/16 -12	9/16 -18
6410-12-08	1-1/16 -12	3/4 -16
6410-12-10	1-1/16 -12	7/8 -14
6410-12-12	1-1/16 -12	1-1/16 -12
6410-12-14	1-1/16 -12	1-3/16 -12
6410-12-16	1-1/16 -12	1-5/16 -12
6410-12-20	1-1/16 -12	1-5/8 -12
6410-14-10	1-3/16 -12	7/8 -14
6410-14-12	1-3/16 -12	1-1/16 -12
6410-14-16	1-3/16 -12	1-5/16 -12
6410-16-04	1-5/16 -12	7-16 -20
6410-16-06	1-5/16 -12	9/16 -18
6410-16-08	1-5/16 -12	3/4 -16
6410-16-10	1-5/16 -12	7/8 -14
6410-16-12	1-5/16 -12	1-1/16 -12
6410-16-14	1-5/16 -12	1-3/16 -12
6410-16-20	1-5/16 -12	1-5/8 -12
6410-16-24	1-5/16 -12	1-7/8 -12
6410-20-06	1-5/8 -12	9/16 -18
6410-20-08	1-5/8 -12	3/4 -16
6410-20-10	1-5/8 -12	7/8 -14
6410-20-12	1-5/8 -12	1-1/16 -12
6410-20-16	1-5/8 -12	1-5/16 -12
6410-20-24	1-5/8 -12	1-7/8 -12
6410-24-12	1-7/8 -12	1-1/16 -12
6410-24-16	1-7/8 -12	1-5/16 -12
6410-24-20	1-7/8 -12	1-5/8 -12
6410-32-12	2-1/2 -12	1-1/16 -12
6410-32-16	2-1/2 -12	1-5/16 -12
6410-32-20	2-1/2 -12	1-5/8 -12
6410-32-24	2-1/2 -12	1-7/8 -12

## 6801 ...JIC - ORB 90° ELBOW

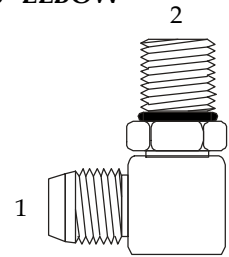

(1) (2)	MALE JIC	MALE ORB
6801-02-02	5/16 -24	5/16 -24
6801-02-04	5/16 -24	7/16 -20
6801-03-03	3/8 -24	3/8 -24
6801-03-04	3/8 -24	7/16 -20
6801-04-02	7/16 -20	5/16 -24
6801-04-03	7/16 -20	3/8 -24
6801-04-04	7/16 -20	7/16 -20
6801-04-05	7/16 -20	1/2 -20
6801-04-06	7/16 -20	9/16 -18
6801-04-08	7/16 -20	3/4 -16
6801-05-04	1/2 -20	7/16 -20
6801-05-05	1/2 -20	1/2 -20
6801-05-06	1/2 -20	9/16 -18
6801-05-08	1/2 -20	3/4 -16
6801-05-10	1/2 -20	7/8 -14
6801-06-04	9/16 -18	7/16 -20
6801-06-05	9/16 -18	1/2 -20
6801-06-06	9/16 -18	9/16 -18
6801-06-08	9/16 -18	3/4 -16
6801-06-10	9/16 -18	7/8 -14
6801-06-12	9/16 -18	1-1/16 -12
6801-08-04	3/4 -16	7/16 -20
6801-08-05	3/4 -16	1/2 -20
6801-08-06	3/4 -16	9/16 -18
6801-08-08	3/4 -16	3/4 -16
6801-08-10	3/4 -16	7/8 -14
6801-08-12	3/4 -16	1-1/16 -12
6801-08-16	3/4 -16	1-5/16 -12
6801-10-06	7/8 -14	9/16 -18
6801-10-08	7/8 -14	3/4 -16
6801-10-10	7/8 -14	7/8 -14
6801-10-12	7/8 -14	1-1/16 -12
6801-10-16	7/8 -14	1-5/16 -12
6801-10-20	7/8 -14	1-5/8 -16
6801-12-06	1-1/16 -12	9/16 -18
6801-12-08	1-1/16 -12	3/4 -16
6801-12-10	1-1/16 -12	7/8 -14
6801-12-12	1-1/16 -12	1-1/16 -12
6801-12-14	1-1/16 -12	1-3/16 -12
6801-12-16	1-1/16 -12	1-5/16 -12
6801-12-20	1-1/16 -12	1-5/8 -12
6801-14-12	1-3/16 -12	1-1/16 -12
6801-14-14	1-3/16 -12	1-3/16 -12
6801-14-16	1-3/16 -12	1-5/16 -12

...continued top of next page

# O-RING BOSS ADAPTERS

...continued from previous page

(1) (2)	MALE JIC	MALE ORB
6801-16-08	1-5/16 - 12	3/4 - 16
6801-16-10	1-5/16 - 12	7/8 - 14
6801-16-12	1-5/16 - 12	1-1/16 - 12
6801-16-14	1-5/16 - 12	1-3/16 - 12
6801-16-16	1-5/16 - 12	1-5/16 - 12
6801-16-20	1-5/16 - 12	1-5/8 - 12
6801-16-24	1-5/16 - 12	1-7/8 - 12
6801-20-12	1-5/8 - 12	1-1/16 - 12
6801-20-14	1-5/8 - 12	1-3/16 - 12
6801-20-16	1-5/8 - 12	1-5/16 - 12
6801-20-20	1-5/8 - 12	1-5/8 - 12
6801-20-24	1-5/8 - 12	1-7/8 - 12
6801-24-16	1-7/8 - 12	1-5/16 - 12
6801-24-20	1-7/8 - 12	1-5/8 - 12
6801-24-24	1-7/8 - 12	1-7/8 - 12
6801-24-32	1-7/8 - 12	2-1/2 - 12
6801-32-24	2-1/2 - 12	1-7/8 - 12
6801-32-32	2-1/2 - 12	2-1/2 - 12

## 6801L ...JIC - ORB 90° LONG ELBOW

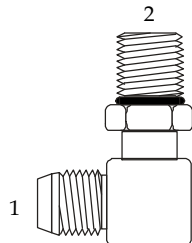

(1) (2)	MALE JIC	MALE ORB
6801-L-04-04	7/16 - 20	7/16 - 20
6801-L-06-06	9/16 - 18	9/16 - 18
6801-L-06-08	9/16 - 18	3/4 - 16
6801-L-08-06	3/4 - 16	9/16 - 18
6801-L-08-08	3/4 - 16	3/4 - 16
6801-L-08-10	3/4 - 16	7/8 - 14
6801-L-10-08	7/8 - 14	3/4 - 16
6801-L-10-10	7/8 - 14	7/8 - 14
6801-L-10-12	7/8 - 14	1-1/16 - 12
6801-L-12-10	1-1/16 - 12	7/8 - 14
6801-L-12-12	1-1/16 - 12	1-1/16 - 12
6801-L-16-12	1-5/16 - 12	1-1/16 - 12
6801-L-16-16	1-5/16 - 12	1-5/16 - 12
6801-L-20-20	1-5/8 - 12	1-5/8 - 12

## 6801LL ...JIC - ORB 90° X LONG ELBOW

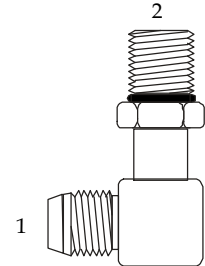

(1) (2)	MALE JIC	MALE ORB
6801-LL-04-04	7/16 - 20	7/16 - 20
6801-LL-04-06	7/16 - 20	9/16 - 18
6801-LL-06-06	9/16 - 18	9/16 - 18
6801-LL-06-08	9/16 - 18	3/4 - 16
6801-LL-08-06	3/4 - 16	9/16 - 18
6801-LL-08-08	3/4 - 16	3/4 - 16
6801-LL-08-10	3/4 - 16	7/8 - 14
6801-LL-10-08	7/8 - 14	3/4 - 16
6801-LL-10-10	7/8 - 14	7/8 - 14
6801-LL-12-12	1-1/16 - 12	1-1/16 - 12
6801-LL-12-16	1-1/16 - 12	1-5/16 - 12
6801-LL-16-12	1-5/16 - 12	1-1/16 - 12
6801-LL-16-16	1-5/16 - 12	1-5/16 - 12
6801-LL-20-20	1-5/8 - 12	1-5/8 - 12

## 6801LLL ...JIC - ORB 90° XX LONG ELBOW

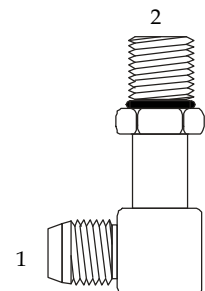

(1) (2)	MALE JIC	MALE ORB
6801-LLL-04-04	7/16 - 20	7/16 - 20
6801-LLL-06-06	9/16 - 18	9/16 - 18
6801-LLL-06-08	9/16 - 18	9/16 - 18
6801-LLL-08-08	3/4 - 16	3/4 - 16
6801-LLL-10-10	7/8 - 14	7/8 - 14
6801-LLL-12-12	1-1/16 - 12	1-1/16 - 12
6801-LLL-16-16	1-5/16 - 12	1-5/16 - 12

# O-RING BOSS ADAPTERS

## 6802 ...JIC to ORB 45° ELBOW

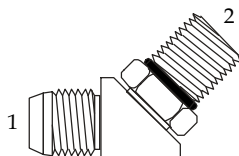

(1) (2)	MALE JIC	MALE ORB
6802-02-02	5/16-24	5/16-24
6802-04-04	7/16-20	7/16-20
6802-04-05	7/16-20	1/2-20
6802-04-06	7/16-20	9/16-18
6802-04-08	7/16-20	3/4-16
6802-05-04	1/2-20	7/16-20
6802-05-05	1/2-20	1/2-20
6802-05-06	1/2-20	9/16-18
6802-06-04	9/16-18	7/16-20
6802-06-05	9/16-18	1/2-20
6802-06-06	9/16-18	9/16-18
6802-06-08	9/16-18	3/4-16
6802-06-10	9/16-18	7/8-14
6802-08-04	3/4-16	7/16-20
6802-08-06	3/4-16	9/16-18
6802-08-08	3/4-16	3/4-16
6802-08-10	3/4-16	7/8-14
6802-08-12	3/4-16	1-1/16-12
6802-10-08	7/8-14	3/4-16
6802-10-10	7/8-14	7/8-14
6802-10-12	7/8-14	1-1/16-12
6802-12-08	1-1/16-12	3/4-16
6802-12-10	1-1/16-12	7/8-14
6802-12-12	1-1/16-12	1-1/16-12
6802-12-16	1-1/16-12	1-5/16-12
6802-16-12	1-5/16-12	1-1/16-12
6802-16-16	1-5/16-12	1-5/16-12
6802-16-20	1-5/16-12	1-5/8-12
6802-20-16	1-5/8-12	1-5/16-12
6802-20-20	1-5/8-12	1-5/8-12
6802-20-24	1-5/8-12	1-7/8-12
6802-24-20	1-7/8-12	1-5/8-12
6802-24-24	1-7/8-12	1-7/8-12
6802-32-32	2-1/2-12	2-1/2-12

## 6803 ... JIC to ORB BRANCH TEE

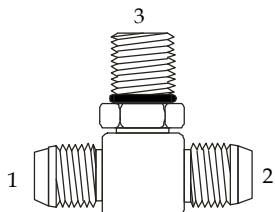

(1) (2) (3)	(1) (2) MALE JIC	(3) MALE ORB
6803-04-04-04	7/16-20	7/16-20
6803-04-04-06	7/16-20	9/16-18
6803-05-05-05	1/2-20	1/2-20
6803-06-06-04	9/16-18	7/16-20
6803-06-06-06	9/16-18	9/16-18
6803-06-06-08	9/16-18	3/4-16

...continued top of next page

...continued

6803-08-08-06	3/4-16	9/16-18
6803-08-08-08	3/4-16	3/4-16
6803-08-08-10	3/4-16	7/8-14
6803-10-10-08	7/8-14	3/4-16
6803-10-10-10	7/8-14	7/8-14
6803-10-10-12	7/8-14	1-1/16-12
6803-12-12-08	1-1/16-12	3/4-16
6803-12-12-10	1-1/16-12	7/8-14
6803-12-12-12	1-1/16-12	1-1/16-12
6803-12-12-16	1-1/16-12	1-5/16-12
6803-14-14-14	1-3/16-12	1-3/16-12
6803-16-16-12	1-5/16-12	1-1/16-12
6803-16-16-16	1-5/16-12	1-5/16-12
6803-20-20-20	1-5/8-12	1-5/8-12
6803-24-24-24	1-7/8-12	1-7/8-12
6803-32-32-32	2-1/2-12	2-1/2-12

## 6804 ...JIC to ORB RUN TEE

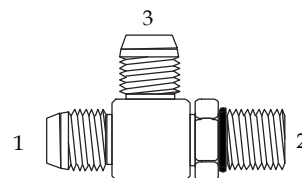

(1) (2) (3)	(1) MALE JIC	(2) MALE ORB	(3) MALE JIC
6804-04-04-04	7/16-20	7/16-20	7/16-20
6804-04-06-04	7/16-20	9/16-18	7/16-20
6804-04-06-06	7/16-20	9/16-18	9/16-18
6804-05-05-05	1/2-20	1/2-20	1/2-20
6804-06-04-06	9/16-18	7/16-20	9/16-18
6804-06-06-04	9/16-18	9/16-18	7/16-20
6804-06-06-06	9/16-18	9/16-18	9/16-18
6804-06-06-08	9/16-18	9/16-18	3/4-16
6804-06-08-06	9/16-18	3/4-16	9/16-18
6804-08-06-08	3/4-16	9/16-18	3/4-16
6804-08-08-08	3/4-16	3/4-16	3/4-16
6804-08-10-08	3/4-16	7/8-14	3/4-16
6804-08-12-08	3/4-16	1-1/16-12	3/4-16
6804-10-08-10	7/8-14	3/4-16	7/8-14
6804-10-10-10	7/8-14	7/8-14	7/8-14
6804-10-10-12	7/8-14	7/8-14	1-1/16-12
6804-10-12-10	7/8-14	1-1/16-12	7/8-14
6804-12-10-12	1-1/16-12	7/8-14	1-1/16-12
6804-12-12-12	1-1/16-12	1-1/16-12	1-1/16-12
6804-12-12-16	1-1/16-12	1-1/16-12	1-5/16-12
6804-14-14-14	1-3/16-12	1-3/16-12	1-3/16-12
6804-16-12-16	1-5/16-12	1-1/16-12	1-5/16-12
6804-16-16-16	1-5/16-12	1-5/16-12	1-5/16-12
6804-20-20-20	1-5/8-12	1-5/8-12	1-5/8-12
6804-24-24-24	1-7/8-12	1-7/8-12	1-7/8-12
6804-32-32-32	2-1/2-12	2-1/2-12	2-1/2-12

# O-RING BOSS ADAPTERS

## 6805 ...ORB to PIPE 90° ELBOW

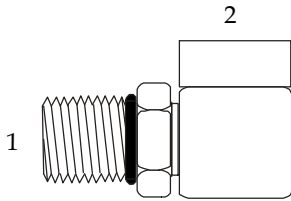

(1) (2)	MALE ORB	FEMALE PIPE
6805-02-04	5/16 - 24	1/4" - 18
6805-04-02	7/16 - 20	1/8" - 27
6805-04-04	7/16 - 20	1/4" - 18
6805-05-02	1/2 - 20	1/8" - 27
6805-06-04	9/16 - 18	1/4" - 18
6805-06-06	9/16 - 18	3/8" - 18
6805-08-06	3/4 - 16	3/8" - 18
6805-08-08	3/4 - 16	1/2" - 14
6805-10-06	7/8 - 14	3/8" - 18
6805-10-08	7/8 - 14	1/2" - 14
6805-12-08	1-1/16 - 12	1/2" - 14
6805-12-12	1-1/16 - 12	3/4" - 14
6805-16-12	1-5/16 - 12	3/4" - 14
6805-16-16	1-5/16 - 12	1" - 11-1/2
6805-20-20	1-5/8 - 12	1-1/4" - 11-1/2
6805-24-24	1-7/8 - 12	1-1/2" - 11-1/2
6805-32-32	2-1/2 - 12	2" - 11-1/2

## 6806 ...ORB to PIPE CONNECTOR

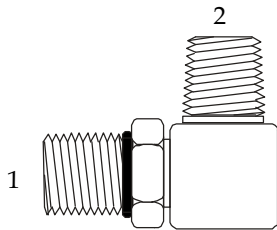

(1) (2)	MALE ORB	MALE PIPE
6806-04-02	7/16 - 20	1/8" - 27
6806-04-04	7/16 - 20	1/4" - 18
6806-05-02	1/2 - 20	1/8" - 27
6806-06-04	9/16 - 18	1/4" - 18
6806-06-06	9/16 - 18	3/8" - 18
6806-08-06	3/4 - 16	3/8" - 18
6806-08-08	3/4 - 16	1/2" - 14
6806-10-08	7/8 - 14	1/2" - 14
6806-12-12	1-1/16 - 12	3/4" - 14
6806-12-16	1-1/16 - 12	1" - 11-1/2
6806-14-12	1-3/16 - 12	3/4" - 14
6806-16-12	1-5/16 - 12	3/4" - 14
6806-16-16	1-5/16 - 12	1" - 11-1/2
6806-20-20	1-5/8 - 12	1-1/4" - 11-1/2
6806-24-24	1-7/8 - 12	1-1/2" - 11-1/2
6806-32-32	2-1/2 - 12	2" - 11-1/2

## 6807 ... ORB 90° ELBOW

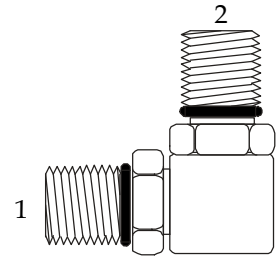

(1) (2)	(1) MALE ORB	(2) MALE ORB
6807-04-04	7/16 - 20	7/16 - 20
6807-06-06	9/16 - 18	9/16 - 18
6807-08-08	3/4 - 16	3/4 - 16
6807-10-10	7/8 - 14	7/8 - 14
6807-12-12	1-1/16 - 12	1-1/16 - 12
6807-16-16	1-5/16 - 12	1-5/16 - 12

## 6809 ... ORB to JIC SWIVEL 90° ELBOW

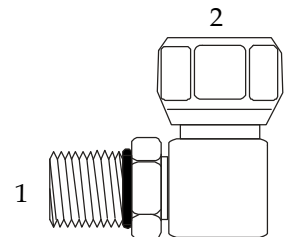

(1) (2)	MALE ORB	FEMALE JIC
6809-04-04	7/16 - 20	7/16 - 20
6809-06-04	9/16 - 18	7/16 - 20
6809-06-06	9/16 - 18	9/16 - 18
6809-08-06	3/4 - 16	9/16 - 18
6809-08-08	3/4 - 16	3/4 - 16
6809-10-10	7/8 - 14	7/8 - 14
6809-12-08	1-1/16 - 12	3/4 - 16
6809-12-12	1-1/16 - 12	1-1/16 - 12
6809-16-16	1-5/16 - 12	1-5/16 - 12
6809-20-20	1-5/8 - 12	1-5/8 - 12
6809-24-24	1-7/8 - 12	1-7/8 - 12

# O-RING BOSS ADAPTERS

## 6900 ...ORB to PIPE SWIVEL

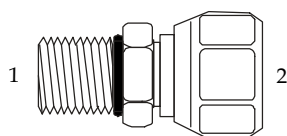

(1) (2)	MALE ORB	FEMALE PIPESWIVEL
Ø900-04-02	7/16 - 20	1/8" - 27
Ø900-04-04	7/16 - 20	1/4" - 18
Ø900-04-06	7/16 - 20	3/8" - 18
Ø900-04-08	7/16 - 20	1/2" - 14
Ø900-05-04	1/2 - 20	1/4" - 18
Ø900-05-08	1/2 - 20	1/2" - 14
Ø900-06-04	9/16 - 18	1/4" - 18
Ø900-06-06	9/16 - 18	3/8" - 18
Ø900-06-08	9/16 - 18	1/2" - 14
Ø900-08-04	3/4 - 16	1/4" - 18
Ø900-08-06	3/4 - 16	3/8" - 18
Ø900-08-08	3/4 - 16	1/2" - 14
Ø900-08-12	3/4 - 16	3/4" - 14
Ø900-10-06	7/8 - 14	3/8" - 18
Ø900-10-08	7/8 - 14	1/2" - 14
Ø900-10-12	7/8 - 14	3/4" - 14
Ø900-12-06	1-1/16 - 12	3/8" - 18
Ø900-12-08	1-1/16 - 12	1/2" - 14
Ø900-12-12	1-1/16 - 12	3/4" - 14
Ø900-12-16	1-1/16 - 12	1" - 11-1/2
Ø900-14-12	1-3/16 - 12	3/4" - 14
Ø900-14-16	1-3/16 - 12	1" - 11-1/2
Ø900-16-08	1-5/16 - 12	1/2" - 14
Ø900-16-12	1-5/16 - 12	3/4" - 14
Ø900-16-16	1-5/16 - 12	1" - 11-1/2
Ø900-16-20	1-5/16 - 12	1-1/4" - 11-1/2
Ø900-20-12	1-5/8 - 12	3/4" - 14
Ø900-20-16	1-5/8 - 12	1" - 11-1/2
Ø900-20-20	1-5/8 - 12	1-1/4" - 11-1/2
Ø900-24-20	1-7/8 - 12	1-1/2" - 11-1/2
Ø900-24-24	1-7/8 - 12	1-1/2" - 11-1/2
Ø900-32-32	2-1/2 - 12	2" - 11-1/2

## ORB ... O-RING BOSS (ORB) O-RINGS

O-RING I.D.	ORB-12	O-RING I.D.
ORB-2	239"	.924"
ORB-3	301"	.1048"
ORB-4	351"	.1171"
ORB-5	414"	.1475"
ORB-6	468"	.1720"
ORB-8	644	.2337"
ORB-10	755"	

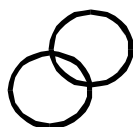

## 6901 ...ORB to PIPE SWIVEL LONG 90°

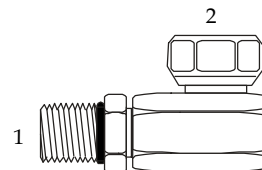

(1) (2)	MALE ORB	FEMALE PIPESWIVEL
6901-04-04	7/16 - 20	1/4" - 18
6901-04-06	7/16 - 20	3/8" - 18
6901-04-08	7/16 - 20	1/2" - 14
6901-06-04	7/16 - 20	1/4" - 18
6901-06-06	9/16 - 18	3/8" - 18
6901-06-08	9/16 - 18	1/2" - 14
6901-08-04	3/4 - 16	1/4" - 18
6901-08-06	3/4 - 16	3/8" - 18
6901-08-08	3/4 - 16	1/2" - 14
6901-08-12	3/4 - 16	3/4" - 14
6901-10-04	7/8 - 14	1/4" - 18
6901-10-06	7/8 - 14	3/8" - 18
6901-10-08	7/8 - 14	1/2" - 14
6901-10-12	7/8 - 14	3/4" - 14
6901-12-06	1-1/16 - 12	3/8" - 18
6901-12-08	1-1/16 - 12	1/2" - 14
6901-12-12	1-1/16 - 12	3/4" - 14
6901-12-16	1-1/16 - 12	1" - 11-1/2
6901-14-12	1-3/16 - 12	3/4" - 14
6901-14-16	1-3/16 - 12	1" - 11-1/2
6901-16-12	1-5/16 - 12	3/4" - 14
6901-16-16	1-5/16 - 12	1" - 11-1/2
6901-16-20	1-5/16 - 12	1-1/4" - 11-1/2
6901-20-12	1-5/8 - 12	3/4" - 14
6901-20-16	1-5/8 - 12	1" - 11-1/2
6901-20-20	1-5/8 - 12	1-1/4" - 11-1/2
6901-24-24	1-7/8 - 12	1-1/2" - 11-1/2
6901-32-32	2-1/2 - 12	2" - 11-1/2

## 6902 ...ORB to PIPE SWIVEL 45° ELBOW

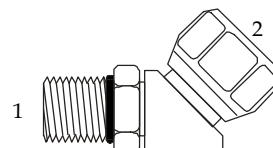

(1) (2)	MALE ORB	FEMALE PIPE SWIVEL
6902-04-04	7/16 - 20	1/4" - 18
6902-04-06	7/16 - 20	3/8" - 18
6902-06-04	9/16 - 18	1/4" - 18
6902-06-06	9/16 - 18	3/8" - 18
6902-06-08	9/16 - 18	1/2" - 14
6902-08-04	3/4 - 16	1/4" - 18
6902-08-06	3/4 - 16	3/8" - 18
6902-08-08	3/4 - 16	1/2" - 14
6902-08-12	3/4 - 16	3/4" - 14
6902-10-06	7/8 - 14	3/8" - 18
6902-10-08	7/8 - 14	1/2" - 14
6902-10-12	7/8 - 14	3/4" - 14
6902-12-06	1-1/16 - 12	3/8" - 18
6902-12-08	1-1/16 - 12	1/2" - 14
6902-12-12	1-1/16 - 12	3/4" - 14
6902-12-16	1-1/16 - 12	1" - 11-1/2
6902-16-12	1-5/16 - 12	3/4" - 14
6902-16-16	1-5/16 - 12	1" - 11-1/2
6902-20-16	1-5/8 - 12	1" - 11-1/2
6902-20-20	1-5/8 - 12	1-1/4" - 11-1/2
6902-24-24	1-7/8 - 12	1-1/2" - 11-1/2

# O-RING FACE SEAL ADAPTERS

Detailed Sizes on the following pages.

**FS 304**

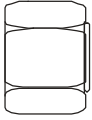

ORFS Cap

**FS 306**

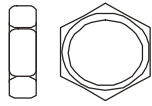

Bulkhead Lock Nut

**FS 318**

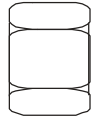

Tube Nut

**FS 319**

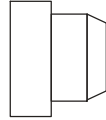

Tube Sleeve

**FS 403**

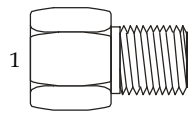

(1) Bore  
(2) Male Face Seal

**FS 2403**

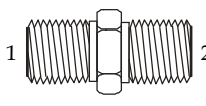

(1) Male Face Seal  
(2) Male Face Seal

**FS 2404**

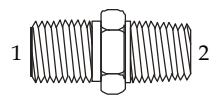

(1) Male Face Seal  
(2) Male NPT

**FS 2406**

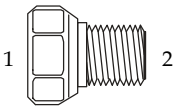

(1) Female Face Seal  
(2) Male Face Seal

**FS 2408**

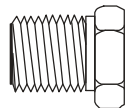

Male Face Seal Plug

**FS 2500**

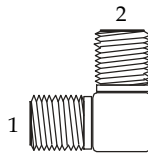

(1) Male Face Seal  
(2) Male Face Seal

**FS 2501**

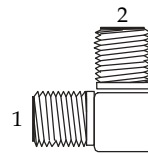

(1) Male Face Seal  
(2) Male NPT

**FS 2503**

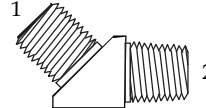

(1) Male Face Seal  
(2) Male NPT

**FS 2601**

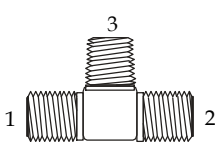

(1)(2) Male Face Seal  
(3) Male NPT

**FS 2603**

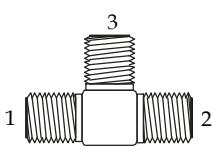

(1)(2)(3)  
Male Face Seal

**FS 2650**

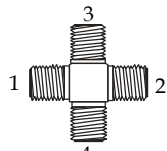

(1)(2)(3)(4)  
Male Face Seal

**FS 2700**

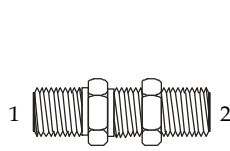

(1) Male Face Seal  
(2) Face Seal Bulkhead

**FS 2701**

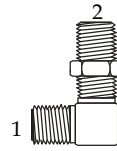

(1) Male Face Seal  
(2) Face Seal Bulkhead

**FS 2702**

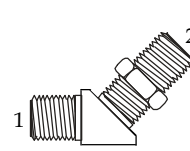

(1) Male Face Seal  
(2) Male Face Seal

**FS 2703**

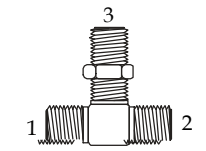

(1)(2) Male Face Seal  
(3) Face Seal Bulkhead

**FS 2704**

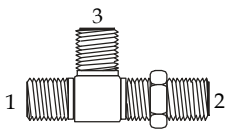

(1)(3) Male Face Seal  
(2) Male Face Seal Bulkhead

**FS 6400**

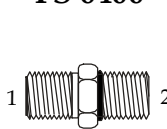

(1) Male Face Seal  
(2) Male ORB

**FS 6400-L**

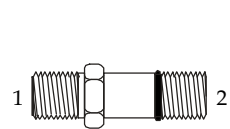

(1) Male Face Seal  
(2) Male ORB Long

**FS 6402**

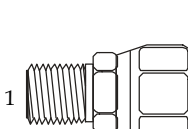

(1) Male Face Seal  
(2) Female JIC

**FS 6403**

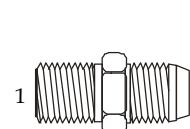

(1) Male Face Seal  
(2) Male JIC

**FS 6500**

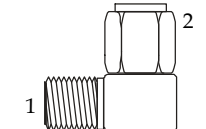

(1) Male Face Seal  
(2) Female Face Seal

**FS 6502**

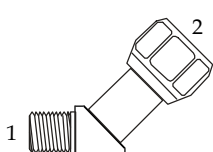

(1) Male Face Seal  
(2) Female JIC

**FS 6503**

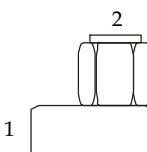

(1) Female NPT  
(2) Female Face Seal

**FS 6504**

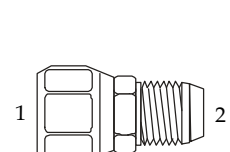

(1) Female Face Seal  
(2) Male JIC

**FS 6505**

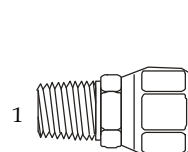

(1) Male NPT  
(2) Female Face Seal

**FS 6600**

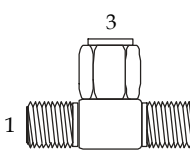

(1)(2) Male Face Seal  
(3) Female Face Seal

**FS 6602**

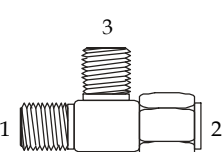

(1)(3) Male Face Seal  
(2) Female Face Seal

**FS 6801**

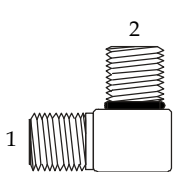

(1) Male Face Seal  
(2) Male Adj. ORB

**FS 6801-L**

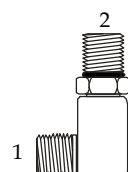

(1) Male Face Seal  
(2) Male Adj. ORB

**FS 6802**

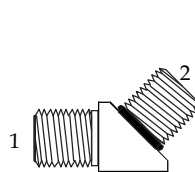

(1) Male Face Seal  
(2) Male Adj. ORB

**FS 6803**

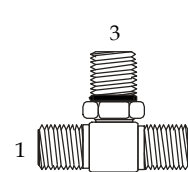

(1)(2) Male Face Seal  
(3) Male Adj. ORB

**FS 6804**

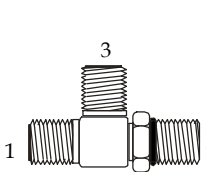

(1)(3) Male Face Seal  
(2) Male Adj. ORB

**FS 6809**

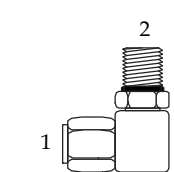

(1) Female Face Seal  
(2) Male Adj. ORB



# O-RING FACE SEAL ADAPTERS

## FS304C ...ORFS CAP

	THREAD
FS304C-04	9/16 - 18
FS304C-06	11/16 - 16
FS304C-08	13/16 - 16
FS304C-10	1 - 14
FS304C-12	1-3/16 - 12
FS304C-16	1-7/16 - 12
FS304C-20	1-11/16 - 12
FS304C-24	2 - 12

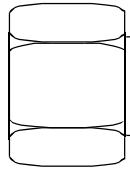

## FS306 ...ORFS BULKHEAD LOCK NUT

	THREAD
FS306-04	9/16-18
FS306-06	11/16-16
FS306-08	13/16-16
FS306-10	1-14
FS306-12	1-3/16-12
FS306-16	1-7/16-12
FS306-20	1-11/16-12
FS306-24	2-12

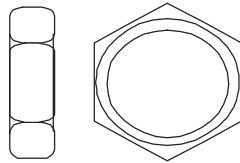

## FS318 ...ORFS NUT

	THREAD
FS318-04	9/16-18
FS318-06	11/16-16
FS318-08	13/16-16
FS318-10	1-14
FS318-12	1-3/16-12
FS318-16	1-7/16-12
FS318-20	1-11/16-12
FS318-24	2-12

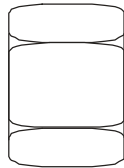

## FS319 ...ORFS SLEEVE

	TUBE O.D.
FS319-04	1/4"
FS319-06	3/8"
FS319-08	1/2"
FS319-10	5/8"
FS319-12	3/4"
FS319-16	1"
FS319-20	1-1/4"
FS319-24	1-1/2"

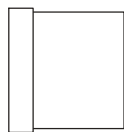

## FS403 ...BORE-MFS STRAIGHT

	(1) BORE	(2) MALE ORFS
FS403-04-04	0.256	9/16-18
FS403-06-06	0.381	11/16-16
FS403-08-08	0.506	13/16-16
FS403-10-10	0.631	1-14
FS403-12-12	0.757	1-3/16-12
FS403-16-16	1.007	1-7/16-12
FS403-20-20	1.258	1-11/16-12
FS403-24-24	1.508	2-12

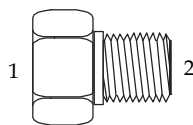

## FS2403 ...ORFS MALE UNION

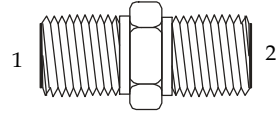

	(1) (2) MALE ORFS	MALE ORFS
FS2403-04-04	9/16-18	9/16-18
FS2403-06-04	11/16-16	9/16-18
FS2403-06-06	11/16-16	11/16-16
FS2403-08-06	13/16-16	11/16-16
FS2403-08-08	13/16-16	13/16-16
FS2403-10-08	1-14	13/16-16
FS2403-10-10	1-14	1-14
FS2403-12-08	1-3/16-12	13/16-12
FS2403-12-10	1-3/16-12	1-14
FS2403-12-12	1-3/16-12	1-3/16-12
FS2403-16-12	1-7/16-12	1-3/16-12
FS2403-16-16	1-7/16-12	1-7/16-12
FS2403-20-20	1-11/16-12	1-11/16-12
FS2403-24-24	2-12	2-12

## FS2404 ...ORFS - MALE PIPE

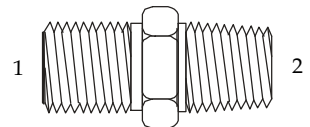

	(1) (2) MALE ORFS	MALE PIPE
FS2404-04-02	9/16-18	1/8"-27
FS2404-04-04	9/16-18	1/4"-18
FS2404-04-06	9/16-18	3/8"-18
FS2404-04-08	9/16-18	1/2"-14
FS2404-06-02	11/16-16	1/8"-27
FS2404-06-04	11/16-16	1/4"-18
FS2404-06-06	11/16-16	3/8"-18
FS2404-06-08	11/16-16	1/2"-14
FS2404-08-04	13/16-16	1/4"-18
FS2404-08-06	13/16-16	3/8"-18
FS2404-08-08	13/16-16	1/2"-14
FS2404-08-12	13/16-16	3/4"-14
FS2404-08-16	13/16-16	1"-11-1/2
FS2404-10-08	1-14	1/2"-14
FS2404-10-12	1-14	3/4"-14
FS2404-10-16	1-14	1"-11-1/2
FS2404-12-08	1-3/16-12	1/2"-14
FS2404-12-12	1-3/16-12	3/4"-14
FS2404-12-16	1-3/16-12	1"-11-1/2
FS2404-16-12	1-7/16-12	3/4"-14
FS2404-16-16	1-7/16-12	1"-11-1/2
FS2404-16-20	1-7/16-12	1-1/4"-11-1/2
FS2404-20-20	1-11/16-12	1-1/4"-11-1/2
FS2404-24-24	2-12	1-1/2"-11-1/2



# O-RING FACE SEAL ADAPTERS

## FS2406 ...ORFS REDUCER/ EXPANDER

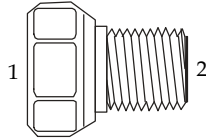

(1) (2)	FEMALE ORFS	MALE ORFS
FS2406-06-04	11/16-16	9/16-18
FS2406-06-06	11/16-16	11/16-16
FS2406-08-04	13/16-16	9/16-18
FS2406-08-06	13/16-16	11/16-16
FS2406-08-12	13/16-16	1-3/16-12
FS2406-10-04	1-14	9/16-18
FS2406-10-06	1-14	11/16-16
FS2406-10-08	1-14	13/16-16
FS2406-12-04	1-3/16-12	9/16-18
FS2406-12-06	1-3/16-12	11/16-16
FS2406-12-08	1-3/16-12	13/16-16
FS2406-12-10	1-3/16-12	1-14
FS2406-12-16	1-3/16-12	1-7/16-12
FS2406-16-08	1-7/16-12	13/16-16
FS2406-16-10	1-7/16-12	1-14
FS2406-16-12	1-7/16-12	1-3/16-12
FS2406-16-20	1-7/16-12	1-11/16-12
FS2406-20-12	1-11/16-12	1-3/16-12
FS2406-20-16	1-11/16-12	1-7/16-12
FS2406-20-24	1-11/16-12	2-12
FS2406-24-16	2-12	1-7/16-12
FS2406-24-20	2-12	1-11/16-12

## FS2408 ...ORFS HEX PLUG

	MALE ORFS
FS2408-04	9/16 - 18
FS2408-06	11/16 - 16
FS2408-08	13/16 - 16
FS2408-10	1 - 14
FS2408-12	1-3/16 - 12
FS2408-16	1-7/16 - 12
FS2408-20	1-11/16 - 12
FS2408-24	2 - 12

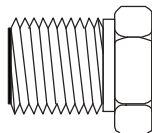

## FS2500 ...ORFS 90° ELBOW

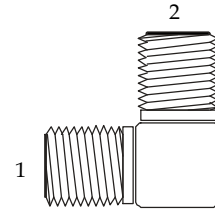

(1) (2)	MALE ORFS	MALE ORFS
FS2500-04-04	9/16-18	9/16-18
FS2500-06-06	11/16-16	11/16-16
FS2500-08-08	13/16-16	13/16-16
FS2500-10-10	1-14	1-14
FS2500-12-12	1-3/16-12	1-3/16-12
FS2500-16-16	1-7/16-12	1-7/16-12
FS2500-20-20	1-11/16-12	1-11/16-12
FS2500-24-24	2-12	2-12

## FS2501 ...ORFS - PIPE 90° ELBOW

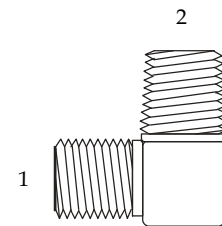

(1) (2)	MALE ORFS	MALE PIPE
FS2501-04-02	9/16-18	1/8"-27
FS2501-04-04	9/16-18	1/4"-18
FS2501-04-06	9/16-18	3/8"-18
FS2501-04-08	9/16-18	1/2"-14
FS2501-06-04	11/16-16	1/4"-18
FS2501-06-06	11/16-16	3/8"-18
FS2501-06-08	11/16-16	1/2"-14
FS2501-08-04	13/16-16	1/4"-18
FS2501-08-06	13/16-16	3/8"-18
FS2501-08-08	13/16-16	1/2"-14
FS2501-08-12	13/16-16	3/4"-14
FS2501-10-08	1-14	1/2"-14
FS2501-10-12	1-14	3/4"-14
FS2501-10-16	1-14	1"-11-1/2
FS2501-12-08	1-3/16-12	1/2"-14
FS2501-12-12	1-3/16-12	3/4"-14
FS2501-12-16	1-3/16-12	1"-11-1/2
FS2501-16-12	1-7/16-12	3/4"-14
FS2501-16-16	1-7/16-12	1"-11-1/2
FS2501-20-16	1-11/16-12	1"-11-1/2
FS2501-20-20	1-11/16-12	1-1/4"-11-1/2
FS2501-24-20	2-12	1-1/4"-11-1/2
FS2501-24-24	2-12	1-1/2"-11-1/2

# O-RING FACE SEAL ADAPTERS

## FS2503 ...ORFS - PIPE 45° ELBOW

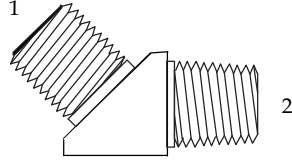

(1) (2)	MALE ORFS	MALE PIPE
FS2503-04-02	9/16-18	1/8" -27
FS2503-04-04	9/16-18	1/4" -18
FS2503-06-04	11/16-16	1/4" -18
FS2503-06-06	11/16-16	3/8" -18
FS2503-08-06	13/16-16	3/8" -18
FS2503-08-08	13/16-16	1/2" -14
FS2503-10-08	1-14	1/2" -14
FS2503-12-12	1-3/16-12	3/4" -14
FS2503-16-16	1-7/16-12	1" -11-1/2
FS2503-20-20	1-11/16-12	1-1/4" -11-1/2

## FS2603 ...ORFS TEE

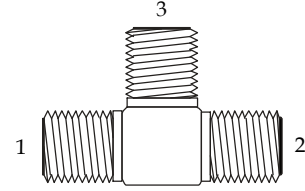

(1) (2) (3)	MALE ORFS	MALE ORFS	MALE ORFS
FS2603-04-04-04	9/16-18	9/16-18	9/16-18
FS2603-06-06-06	11/16-16	11/16-16	11/16-16
FS2603-06-06-08	11/16-16	11/16-16	13/16-16
FS2603-06-08-08	11/16-16	13/16-16	13/16-16
FS2603-08-06-08	13/16-16	11/16-16	13/16-16
FS2603-08-08-08	13/16-16	13/16-16	13/16-16
FS2603-10-10-10	1-14	1-14	1-14
FS2603-10-10-12	1-14	1-14	1-14
FS2603-12-12-04	1-3/16-12	1-3/16-12	9/16-18
FS2603-12-12-06	1-3/16-12	1-3/16-12	11/16-16
FS2603-12-12-12	1-3/16-12	1-3/16-12	1-3/16-12
FS2603-12-12-16	1-3/16-12	1-3/16-12	1-7/16-12
FS2603-16-16-12	1-7/16-12	1-7/16-12	1-3/16-12
FS2603-16-16-16	1-7/16-12	1-7/16-12	1-7/16-12
FS2603-20-20-16	1-11/16-12	1-11/16-12	1-7/16-12
FS2603-20-20-20	1-11/16-12	1-11/16-12	1-11/16-12
FS2603-24-24-24	2-12	2-12	2-12

## FS2601 ...ORFS - PIPE BRANCH TEE

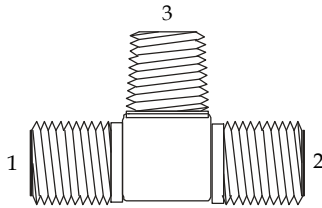

(1)(2)(3)	(1)(2) MALE ORFS	(3) MALE ORFS
FS2601-04-04-04	9/16-18	9/16-18
FS2601-06-06-04	11/16-16	9/16-18
FS2601-06-06-06	11/16-16	11/16-16
FS2601-08-08-06	13/16-16	11/16-16
FS2601-08-08-08	13/16-16	13/16-16
FS2601-12-12-12	1-3/16-12	1-3/16-12
FS2601-16-16-16	1-7/16-12	1-7/16-12
FS2601-20-20-20	1-11/16-12	1-11/16-12

## FS2650 ...ORFS CROSS

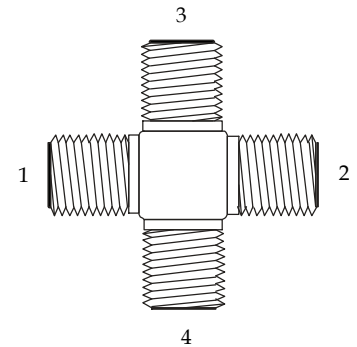

(1)(2)(3)(4)	MALE ORFS
FS2650-04-04-04-04	9/16-18
FS2650-06-06-06-06	11/16-16
FS2650-08-08-08-08	13/16-16
FS2650-10-10-10-10	1-14
FS2650-12-12-12-12	1-3/16-12
FS2650-16-16-16-16	1-7/16-12
FS2650-20-20-20-20	1-11/16-12
FS2650-24-24-24-24	2-12

## O-RING FACE SEAL THREADS

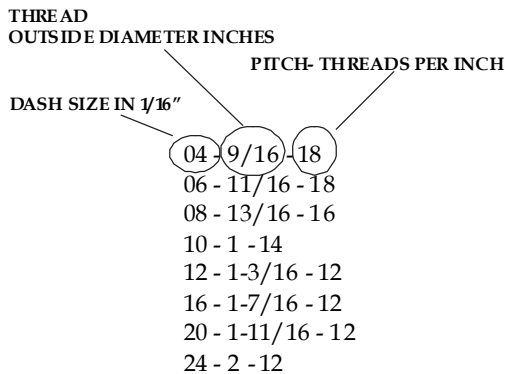

# O-RING FACE SEAL ADAPTERS

## FS2700 ...ORFS BULKHEAD

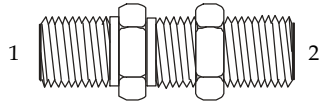

(1) (2)	MALE ORFS	MALE ORFS
FS2700-LN-04-04	9/16-18	9/16-18
FS2700-LN-06-06	11/16-16	11/16-16
FS2700-LN-08-08	13/16-16	13/16-16
FS2700-LN-10-10	1-14	1-14
FS2700-LN-12-12	1-3/16-12	1-3/16-12
FS2700-LN-16-16	1-7/16-12	1-7/16-12
FS2700-LN-20-20	1-11/16-12	1-11/16-12
FS2700-LN-24-24	2-12	2-12

## FS2703 ...ORFS BULKHEAD UNION BRANCH TEE

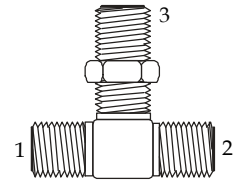

(1) (2) (3)	MALE ORFS
FS2703-04-04-04	9/16-18
FS2703-06-06-06	11/16-16
FS2703-08-08-08	13/16-16
FS2703-10-10-10	1-14
FS2703-12-12-12	1-3/16-12
FS2703-16-16-16	1-7/16-12
FS2703-20-20-20	1-11/16-12
FS2703-24-24-24	2-12

## FS2701 ...ORFS BULKHEAD UNION 90°

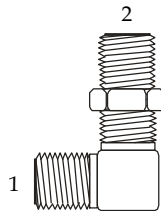

(1) (2)	MALE ORFS	MALE ORFS
FS2701-LN-04-04	9/16-18	9/16-18
FS2701-LN-06-06	11/16-16	11/16-16
FS2701-LN-08-08	13/16-16	13/16-16
FS2701-LN-08-10	13/16-16	1-14
FS2701-LN-10-10	1-14	1-14
FS2701-LN-12-12	1-3/16-12	1-3/16-12
FS2701-LN-16-16	1-7/16-12	1-7/16-12
FS2701-LN-20-20	1-11/16-12	1-11/16-12
FS2701-LN-24-24	2-12	2-12

## FS2704 ...ORFS BULKHEAD UNION RUN TEE

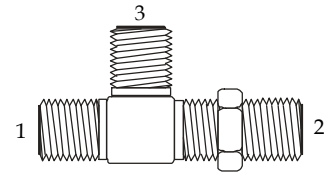

(1) (2) (3)	MALE ORFS
FS2703-04-04-04	9/16-18
FS2703-06-06-06	11/16-16
FS2703-08-08-08	13/16-16
FS2703-10-10-10	1-14
FS2703-12-12-12	1-3/16-12
FS2703-16-16-16	1-7/16-12
FS2703-20-20-20	1-11/16-12
FS2703-24-24-24	2-12

## FS2702 ...ORFS BULKHEAD UNION 45°

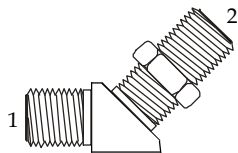

(1) (2)	MALE ORFS	MALE ORFS
FS2702-04-04	9/16-18	9/16-18
FS2702-06-06	11/16-16	11/16-16
FS2702-08-08	13/16-16	13/16-16
FS2702-10-10	1-14	1-14
FS2702-12-12	1-3/16-12	1-3/16-12
FS2702-16-16	1-7/16-12	1-7/16-12
FS2702-20-20	1-11/16-12	1-11/16-12
FS2702-24-24	2-12	2-12

## O-RING FACE SEAL THREADS

THREAD	OUTSIDE DIAMETER INCHES	PITCH - THREADS PER INCH
04	9/16	18
06	11/16	16
08	13/16	16
10	1	14
12	1-3/16	12
16	1-7/16	12
20	1-11/16	12
24	2	12

# O-RING FACE SEAL ADAPTERS

## FS6400 ...ORFS to ORB

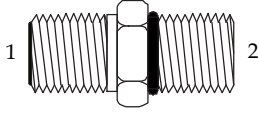

(1) (2)	MALE ORFS	MALE ORB
FS6400-04-04	9/16-18	7/16 - 20
FS6400-04-05	9/16-18	1/2-20
FS6400-04-06	9/16-18	9/16-18
FS6400-04-08	9/16-18	3/4-16
FS6400-06-03	11/16-18	7/16 - 20
FS6400-06-05	11/16-16	1/2 - 20
FS6400-06-06	11/16-16	9/16 - 18
FS6400-06-08	11/16-16	3/4-16
FS6400-06-10	11/16-16	7/8-14
FS6400-08-04	13/16-16	7/16-20
FS6400-08-06	13/16-16	9/16-18
FS6400-08-08	13/16-16	3/4 - 16
FS6400-08-10	13/16-16	7/8-14
FS6400-08-12	13/16-16	1-1/16 - 12
FS6400-08-16	13/16-16	1-5/16-12
FS6400-10-06	1-14	9/16-18
FS6400-10-08	1-14	3/4 - 16
FS6400-10-10	1-14	7/8-14
FS6400-10-12	1-14	1-1/16 - 12
FS6400-12-08	1-3/16-12	3/4 - 16
FS6400-12-10	1-3/16-12	7/8-14
FS6400-12-12	1-3/16-12	1-1/16 - 12
FS6400-12-16	1-3/16-12	1-5/16 - 12
FS6400-16-12	1-7/16-12	1-1/16 - 12
FS6400-16-16	1-7/16-12	1-5/16 - 12
FS6400-16-20	1-7/16-12	1-5/8 - 12
FS6400-20-16	1-11/16-12	1-5/16 - 12
FS6400-20-20	1-11/16-12	1-5/8-12
FS6400-20-24	1-11/16-12	1-7/8-12
FS6400-24-20	2-12	1-5/8-12
FS6400-24-24	2-12	1-7/8-12

## FS6400 ...ORFS TO ORB LONG

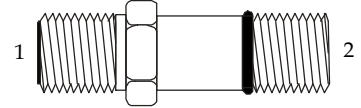

(1) (2)	MALE ORFS	MALE ORB
FS6400-04-04	9/16-18	7/16 - 20
FS6400-06-06	11/16-18	9/16 - 18
FS6400-08-08	13/16-16	3/4-16
FS6400-10-10	1-14	7/8-14
FS6400-12-12	1-3/16-12	1-1/16 - 12
FS6400-16-16	1-7/16-12	1-5/16-12
FS6400-20-20	1-11/16-12	1-5/8 - 12
FS6400-24-24	2-12	1-7/8-12

## FS6402 ...ORFS - JIC SWIVEL

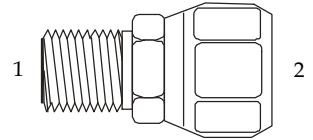

(1) (2)	MALE ORFS	FEMALE JIC
FS6402-04-04	9/16-18	7/16 - 20
FS6402-06-06	11/16-18	9/16 - 18
FS6402-08-08	13/16-16	3/4-16
FS6402-10-10	1-14	7/8-14
FS6402-12-12	1-3/16-12	1-1/16 - 12
FS6402-16-16	1-7/16-12	1-5/16-12
FS6402-20-20	1-11/16-12	1-5/8 - 12

## FS6403 ...ORFS - MALE JIC

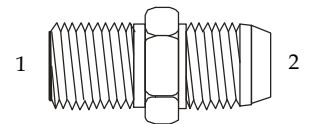

(1) (2)	MALE ORFS	MALE JIC
FS6403-04-04	9/16-18	9/16-18
FS6403-06-06	11/16-16	11/16-16
FS6403-08-08	13/16-16	13/16-16
FS6403-10-10	1-14	1-14
FS6403-12-12	1-3/16-12	1-3/16-12
FS6403-16-16	1-7/16-12	1-7/16-12
FS6403-20-20	1-11/16-12	1-11/16-12
FS6403-24-24	2-12	2-12

## O-RING FACE SEAL THREADS

THREAD OUTSIDE DIAMETER INCHES	PITCH- THREADS PER INCH
04	9/16 - 18
06	11/16 - 18
08	13/16 - 16
10	1 - 14
12	1-3/16 - 12
16	1-7/16 - 12
20	1-11/16 - 12
24	2 - 12

DASH SIZE IN 1/16"

# O-RING FACE SEAL ADAPTERS

## FS6500 ...ORFS 90° ELBOW

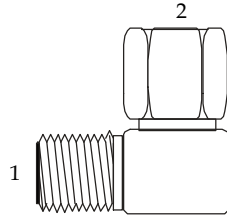

(1) (2)	MALE ORFS	FEMALE ORFS
FS6500-04-04	9/16-18	9/16-18
FS6500-04-06	9/16-18	11/16-16
FS6500-06-06	11/16-16	11/16-16
FS6500-08-06	13/16-16	11/16-16
FS6500-08-08	13/16-16	13/16-16
FS6500-08-12	13/16-16	1-3/16-12
FS6500-10-10	1-14	1-14
FS6500-12-12	1-3/16-12	1-3/16-12
FS6500-16-16	1-7/16-12	1-7/16-12
FS6500-20-20	1-11/16-12	1-11/16-12
FS6500-24-20	2-12	1-11/16-12
FS6500-24-24	2-12	2-12

## FS6502 ...ORFS 45° ELBOW

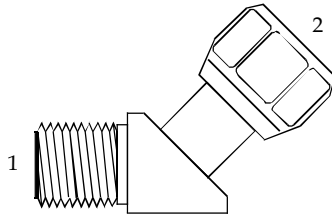

(1) (2)	MALE ORFS	FEMALE ORFS
FS6502-04-04	9/16 - 18	9/16 - 18
FS6502-06-06	11/16 - 16	11/16 - 16
FS6502-08-08	13/16 - 16	13/16 - 16
FS6502-10-10	1 - 14	1 - 14
FS6502-12-12	1-3/16 - 12	1-3/16 - 12
FS6502-16-16	1-7/16 - 12	1-7/16 - 12

## FS6503 ...FEMALE PIPE - ORFS

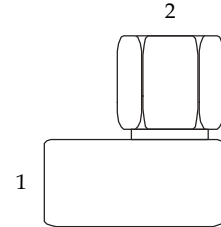

(1) (2)	FEMALE PIPE	FEMALE ORFS
FS6503-04-04	1/4-18	9/16-18
FS6503-06-06	3/8-18	11/16-16

## FS6504 ...ORFS SWIVEL - MALE JIC

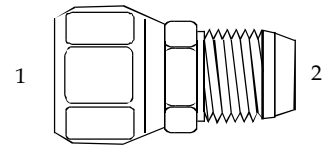

(1) (2)	FEMALE ORFS	MALE JIC
FS6504-04-04	9/16-18	9/16-18
FS6504-06-06	11/16-16	11/16-16
FS6504-08-04	13/16-16	9/16-18
FS6504-08-08	13/16-16	13/16-16
FS6504-10-10	1-14	1-14
FS6504-12-04	1-3/16-12	9/16-18
FS6504-12-12	1-3/16-12	1-3/16-12
FS6504-16-04	1-7/16-12	9/16-18
FS6504-16-16	1-7/16-12	1-7/16-12
FS6504-20-20	1-11/16-12	1-11/16-12
FS6504-24-24	2-12	2-12

## FS6505 ...MALE PIPE - ORFS SWIVEL

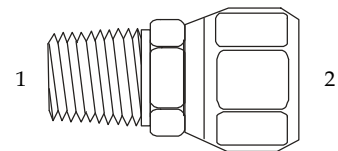

(1) (2)	MALE PIPE	FEMALE ORFS
FS6505-04-06	1/4-18	11/16-16

# O-RING FACE SEAL ADAPTERS

## FS6600 ...ORFS TO SWIVEL BRANCH TEE

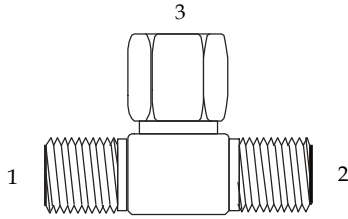

(1) (2) (3)	(1)(2)MALE ORFS	(3)FEMALE ORFS
FS6600-04-04-04	9/16-18	9/16-18
FS6600-06-06-06	11/16-16	11/16-16
FS6600-08-08-08	13/16-16	13/16-16
FS6600-10-10-10	1-14	1-14
FS6600-12-12-12	1-3/16-12	1-3/16-12
FS6600-16-16-16	1-7/16-12	1-7/16-12
FS6600-20-20-20	1-11/16-12	1-11/16-12
FS6600-24-24-24	2-12	2-12

## FS6602 ...ORFS TO SWIVEL RUN TEE

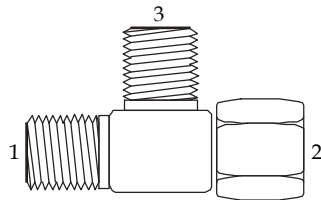

(1) (2) (3)	MALE ORFS	MALE ORFS	MALE ORFS
FS6602-04-04-04	9/16-18	9/16-18	9/16-18
FS6602-06-06-06	11/16-16	11/16-16	11/16-16
FS6602-06-06-08	11/16-16	11/16-16	13/16-16
FS6602-08-08-08	13/16-16	13/16-16	13/16-16
FS6602-10-10-10	1-14	1-14	1-14
FS6602-12-10-10	1-3/16-12	1-14	1-14
FS6602-12-12-10	1-3/16-12	1-3/16-12	1-14
FS6602-12-12-12	1-3/16-12	1-3/16-12	1-3/16-12
FS6602-16-16-16	1-7/16-12	1-7/16-12	1-7/16-12
FS6602-20-20-20	1-11/16-12	1-11/16-12	1-11/16-12
FS6602-24-24-24	2-12	2-12	2-12

## FS6801 ... ORFS - MALE ORB 90° ELBOW

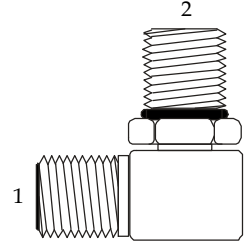

(1) (2)	MALE ORFS	MALE ORB
FS6801-04-04	9/16-18	7/16 - 20
FS6801-04-06	9/16-18	9/16-18
FS6801-04-08	9/16-18	3/4-16
FS6801-06-04	11/16-18	7/16 - 20
FS6801-06-05	11/16-16	1/2 - 20
FS6801-06-06	11/16-16	9/16 - 18
FS6801-06-08	11/16-16	3/4-16
FS6801-06-10	11/16-16	7/8-14
FS6801-06-12	11/16-16	1-1/16-12
FS6801-06-16	11/16-16	1-5/16-12
FS6801-08-06	13/16-16	9/16-18
FS6801-08-08	13/16-16	3/4 - 16
FS6801-08-10	13/16-16	7/8-14
FS6801-08-12	13/16-16	1-1/16 - 12
FS6801-10-08	1-14	3/4 - 16
FS6801-10-10	1-14	7/8-14
FS6801-10-12	1-14	1-1/16 - 12
FS6801-12-08	1-3/16-12	3/4 - 16
FS6801-12-10	1-3/16-12	7/8-14
FS6801-12-12	1-3/16-12	1-1/16 - 12
FS6801-12-16	1-3/16-12	1-5/16 - 12
FS6801-16-12	1-7/16-12	1-1/16 - 12
FS6801-16-14	1-7/16-12	1-3/16 - 12
FS6801-16-16	1-7/16-12	1-5/16 - 12
FS6801-16-20	1-7/16-12	1-5/8 - 12
FS6801-20-12	1-11/16-12	1-1/16 - 12
FS6801-20-16	1-11/16-12	1-5/16 - 12
FS6801-20-20	1-11/16-12	1-5/8-12
FS6801-20-24	1-11/16-12	1-7/8-12
FS6801-24-20	2-12	1-5/8-12
FS6801-24-24	2-12	1-7/8-12

## FS6801-L ...ORFS - MALE ORB 90° LONG

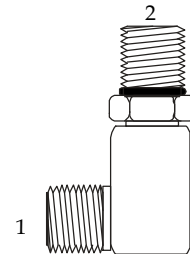

(1) (2)	MALE ORFS	MALE ORB
FS6801-L-04-04	9/16-18	7/16 - 20
FS6801-L-06-06	11/16-16	9/16-18
FS6801-L-08-08	13/16-16	3/4-16
FS6801-L-10-10	1-14	7/8-14
FS6801-L-12-12	1-3/16-12	1-1/16-12
FS6801-L-16-16	1-7/16-12	1-5/16-12

# O-RING FACE SEAL ADAPTERS

## FS6802 ...ORFS - ORB 45° ELBOW

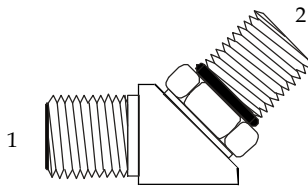

(1) (2)	MALE ORFS	MALE ORB
FS6802-04-03	9/16-18	3/8-24
FS6802-04-04	9/16-18	7/16 - 20
FS6802-04-06	9/16-18	9/16-18
FS6802-06-04	11/16-18	7/16 - 20
FS6802-06-06	11/16-16	9/16 - 18
FS6802-06-08	11/16-16	3/4-16
FS6802-06-10	11/16-16	7/8-14
FS6802-08-06	13/16-16	9/16-18
FS6802-08-08	13/16-16	3/4 - 16
FS6802-08-10	13/16-16	7/8-14
FS6802-08-12	13/16-16	1-1/16 - 12
FS6802-10-08	1-14	3/4 - 16
FS6802-10-10	1-14	7/8-14
FS6802-10-12	1-14	1-1/16 - 12
FS6802-12-08	1-3/16-12	3/4 - 16
FS6802-12-10	1-3/16-12	7/8-14
FS6802-12-12	1-3/16-12	1-1/16 - 12
FS6802-12-16	1-3/16-12	1-5/16 - 12
FS6802-16-12	1-7/16-12	1-1/16 - 12
FS6802-16-16	1-7/16-12	1-5/16 - 12
FS6802-16-20	1-7/16-12	1-5/8 - 12
FS6802-20-20	1-11/16-12	1-5/8-12
FS6802-24-24	2-12	1-7/8-12

## FS6803 ...ORFS - ORB BRANCH TEE

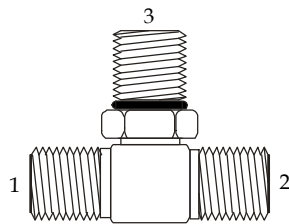

(1) (2) (3)	(1) (2) MALE ORFS	(3) MALE ORB
FS6803-04-04-04	9/16-18	7/16 - 20
FS6803-06-06-06	11/16-16	9/16-18
FS6803-06-06-08	11/16-16	3/4-16
FS6803-08-08-08	13/16-16	3/4 - 16
FS6803-10-10-10	1-14	7/8-14
FS6803-12-12-10	13/16-16	7/8-14
FS6803-12-12-12	13/16-16	1-1/16 - 12
FS6803-12-12-16	13/16-16	1-5/16 - 12
FS6803-16-16-16	1-7/16-12	1-5/16 - 12
FS6803-20-20-20	1-11/16-12	1-5/8-12
FS6803-24-24-24	2-12	1-7/8-12

## FS6804 ...ORFS - ORB RUN TEE

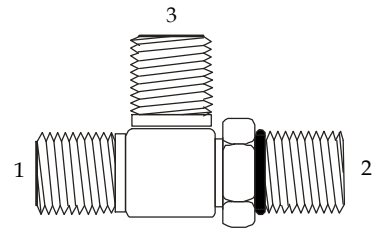

(1) (2) (3)	(1) MALE ORFS	(2) MALE ORB	(3) MALE ORFS
FS6804-04-04-04	9/16-18	7/16-20	9/16-18
FS6804-04-04-06	9/16-18	7/16-20	11/16-16
FS6804-04-06-04	9/16-18	9/16-18	9/16-18
FS6804-06-04-06	11/16-16	7/16-20	11/16-16
FS6804-06-06-06	11/16-16	9/16-18	11/16-16
FS6804-06-08-06	11/16-16	3/4-16	11/16-16
FS6804-08-06-08	13/16-16	9/16-18	13/16-16
FS6804-08-08-08	13/16-16	3/4-16	13/16-16
FS6804-08-10-08	13/16-16	7/8-14	13/16-16
FS6804-08-12-08	13/16-16	1-1/16-12	13/16-16
FS6804-10-10-10	1-14	7/8-14	1-14
FS6804-10-12-10	1-14	1-1/16-12	1-14
FS6804-12-12-12	1-3/16-12	1-1/16-12	1-3/16-12
FS6804-12-12-16	1-3/16-12	1-1/16-12	1-7/16-12
FS6804-16-16-16	1-7/16-12	1-5/16-12	1-7/16-12
FS6804-20-20-20	1-11/16-12	1-5/8-12	1-11/16-12
FS6804-24-24-24	2-12	1-7/8-12	2-12

## FS6809 ...ORFS SWIVEL - MALE ORB 90°

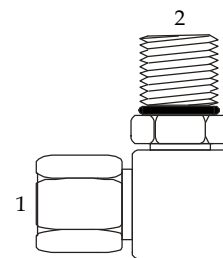

(1) (2)	FEMALE ORFS	MALE ORB
FS6809-04-04	9/16 - 18	7/16-20
FS6809-06-06	11/16 - 16	9/16-18
FS6809-08-08	13/16 - 16	3/4-16
FS6809-10-10	1 - 14	7/8-14
FS6809-12-12	1-3/16 - 12	1-1/16-12
FS6809-16-16	1-7/16 - 12	1-5/16-12
FS6809-20-20	1-11/16-12	1-5/8-12
FS6809-24-24	2-12	1-7/8-12

# BSPP ADAPTERS

## 9033 ...BSPP CAP

### Female BSPP Thread

9033-04	1/4-19
9033-06	3/8-19
9033-08	1/2-14
9033-10	5/8-14
9033-12	3/4-14
9033-16	1-11
9033-20	1-1/4-11

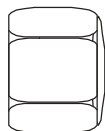

## 9030 ...BSPP HEX PLUG

### BSPP Thread

9030-02	1/8-28
9030-04	1/4-19
9030-06	3/8-19
9030-08	1/2-14
9030-10	5/8-14
9030-12	3/4-14
9030-16	1-11
9030-20	1-1/4-11
9030-24	1-1/2-11

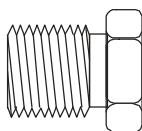

## 9015 ...MALE BSPP X FEMALE BSPP SWIVEL

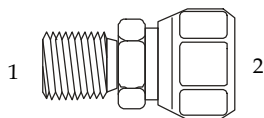

	Male BSPP	Female BSPP
(1) (2)	1/4-19	1/4-19
9015-04-04	1/4-19	1/4-19
9015-04-06	3/8-19	3/8-19
9015-06-06	1/2-14	1/2-14
9015-08-08	5/8-14	5/8-14
9015-10-10	3/4-14	3/4-14
9015-12-12	1-11	1-11
9015-16-16	1-1/4-11	1-1/4-11
9015-20-20	1-1/2-11	1-1/2-11

## 9000 ...BSPP MALE UNION

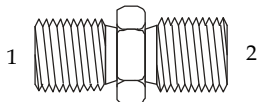

	Male BSPP	Male BSPP
(1) (2)	1/4-19	1/8-28
9000-04-02	1/4-19	1/4-19
9000-04-04	3/8-19	1/4-19
9000-06-04	3/8-19	3/8-19
9000-06-06	1/2-14	1/4-19
9000-08-04	1/2-14	3/8-19
9000-08-06	1/2-14	1/2-14
9000-08-08	5/8-14	5/8-14
9000-10-10	3/4-14	1/2-14
9000-12-08	3/4-14	3/4-14
9000-12-12	1-11	1-11
9000-16-12	1-1/4-11	1-1/4-11
9000-16-16	1-1/2-11	1-1/2-11

## 9060 ...BSPP 90° ELBOW

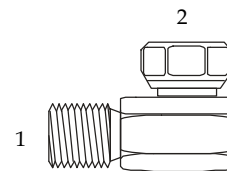

(1) (2)	Male BSPP	Female BSPP
9060-04-04	1/4-19	1/4-19
9060-06-06	3/8-19	3/8-19
9060-08-08	1/2-14	1/2-14
9060-10-10	5/8-14	5/8-14
9060-12-12	3/4-14	3/4-14
9060-16-16	1-11	1-11
9060-20-20	1-1/4-11	1-1/4-11
9060-24-24	1-1/2-11	1-1/2-11

## 9007 ...BSPP to PIPE ADAPTER

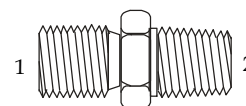

(1) (2)	Male BSPP	Male NPT
9007-04-02	1/4-19	1/8-27
9007-04-04	1/4-19	1/4-18
9007-04-06	1/4-19	3/8-18
9007-04-08	1/4-19	1/2-14
9007-06-04	3/8-19	1/4-18
9007-06-06	3/8-19	3/8-18
9007-06-08	3/8-19	1/2-14
9007-06-12	3/8-19	3/4-14
9007-08-04	1/2-14	1/4-18
9007-08-06	1/2-14	3/8-18
9007-08-08	1/2-14	1/2-14
9007-08-12	1/2-14	3/4-14
9007-10-08	5/8-14	1/2-14
9007-10-12	5/8-14	3/4-14
9007-12-04	3/4-14	1/4-18
9007-12-06	3/4-14	3/8-18
9007-12-08	3/4-14	1/2-14
9007-12-12	3/4-14	3/4-14
9007-12-16	3/4-14	1-11
9007-16-12	1-11	3/4-14
9007-16-16	1-11	1-11-1/2
9007-20-20	1-1/4-11	1-1/4-11-1/2



# BSPP ADAPTERS

## 9240 ...JIC to BSPP SWIVEL

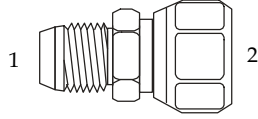

(1) (2)	Male JIC	FEMALE BSPP
9240-04-02	7/16-20	1/8-28
9240-04-04	7/16-20	1/4-19
9240-04-06	7/16-20	3/8-19
9240-06-04	9/16-18	1/4-19
9240-06-06	9/16-18	3/8-19
9240-06-08	9/16-18	1/2-14
9240-08-06	3/4-16	3/8-19
9240-08-08	3/4-16	1/2-14
9240-08-10	3/4-16	5/8-14
9240-08-12	3/4-16	3/4-14
9240-10-10	7/8-14	5/8-14
9240-12-12	1-1/16-12	7/8-14
9240-16-16	1-5/16-12	1-11
9240-20-20	1-5/8-12	1-1/4-11

## 9002.... JIC to BSPP MALE

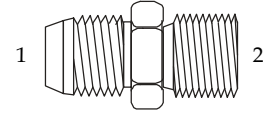

(1) (2)	JIC Male	BSPP Male
9002-04-02	7/16-20	1/8-28
9002-04-04	7/16-20	1/4-19
9002-04-06	7/16-20	3/8-19
9002-05-04	1/2-20	1/4-19
9002-05-06	1/2-20	3/8-19
9002-06-02	9/16-18	1/8-28
9002-06-04	9/16-18	1/4-19
9002-06-06	9/16-18	3/8-19
9002-06-08	9/16-18	1/2-14
9002-06-10	9/16-18	5/8-14
9002-06-12	9/16-18	3/4-14
9002-08-04	3/4-16	1/4-19
9002-08-06	3/4-16	3/8-19
9002-08-08	3/4-16	1/2-14
9002-08-10	3/4-16	5/8-14
9002-08-12	3/4-16	3/4-14
9002-08-16	3/4-16	1-11
9002-10-06	7/8-14	3/8-19
9002-10-08	7/8-14	1/2-14
9002-10-10	7/8-14	5/8-14
9002-10-12	7/8-14	3/4-14
9002-12-08	1-1/16-12	1/2-14
9002-12-10	1-1/16-12	5/8-14
9002-12-12	1-1/16-12	3/4-14
9002-12-16	1-1/16-12	1-11
9002-16-12	1-5/16-12	3/4-14
9002-16-16	1-5/16-12	1-1
9002-16-20	1-5/16-12	1-1/4-11
9002-20-20	1-5/8-12	1-1/4-11
9002-20-24	1-5/8-12	1-1/2-11
9002-24-24	1-7/8-12	1-1/2-11

## 9035 ...BSPP to FEMALE PIPE

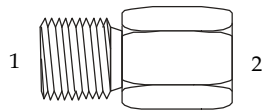

(1) (2)	Male BSPP	Female NPT
9035-02-02	1/8-28	1/8-27
9035-04-04	1/4-19	1/4-18
9035-04-06	3/8-19	3/8-18
9035-06-04	1/4-19	1/4-18
9035-06-06	3/8-19	3/8-18
9035-06-08	1/2-14	1/2-14
9035-08-06	3/8-19	3/8-18
9035-08-08	1/2-14	1/2-14
9035-12-08	5/8-14	1/2-14
9035-12-12	3/4-14	3/4-14
9035-16-16	5/8-14	1-11-1/2
9035-20-20	7/8-14	1-1/4-11-1/2
9035-24-24	1-11	1-1/2-11-1/2

## BSPP THREADS

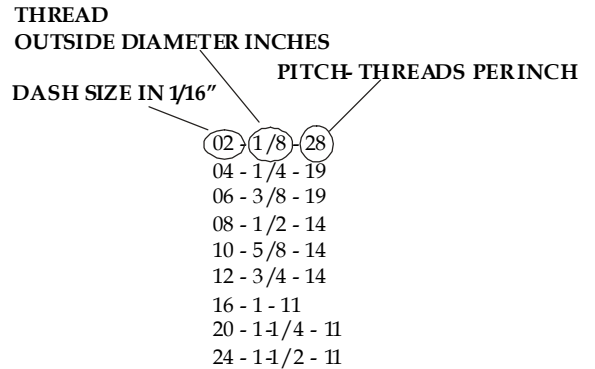

# BSPP ADAPTERS

## 9059... JIC to BSPP 90° ELBOW

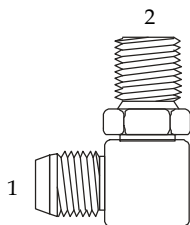

(1) (2)	Male JIC	BSPP Male
9059-04-02	7/16-20	1/8-28
9059-04-04	7/16-20	1/4-19
9059-04-06	7/16-20	3/8-19
9059-06-04	9/16-18	1/4-19
9059-06-06	9/16-18	3/8-19
9059-06-08	9/16-18	1/2-14
9059-08-04	3/4-16	1/4-19
9059-08-06	3/4-16	3/8-19
9059-08-08	3/4-16	1/2-14
9059-08-12	3/4-16	3/4-14
9059-10-06	7/8-14	3/8-19
9059-10-08	7/8-14	1/2-14
9059-12-08	1-1/16-12	1/2-14
9059-12-12	1-1/16-12	3/4-14
9059-16-16	1-5/16-12	1-11
9059-16-20	1-5/16-12	1-1/4-11
9059-20-20	1-5/8-12	1-1/4-11

## 9021 ...BSPP to JIC SWIVEL ADAPTER

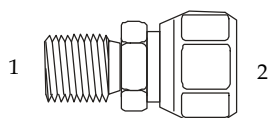

(1) (2)	BSPP Male	Female JIC
9021-04-04	1/4-19	7/16-20
9021-04-06	1/4-19	9/16-18
9021-06-04	3/8-19	7/16-20
9021-06-06	3/8-19	9/16-18
9021-06-08	3/8-19	3/4-16
9021-08-04	1/2-14	7/16-20
9021-08-06	1/2-14	9/16-18
9021-08-08	1/2-14	3/4-16
9021-08-12	1/2-14	1-1/16-12
9021-10-08	5/8-14	3/4-16
9021-12-12	3/4-14	1-1/16-12
9021-16-16	1-11	1-5/16-12

**BSPP THREADS**

THREAD  
OUTSIDE DIAMETER INCHES  
DASH SIZE IN 1/16"

PITCH- THREADS PER INCH

02 - 1/8 - 28
04 - 1/4 - 19
06 - 3/8 - 19
08 - 1/2 - 14
10 - 5/8 - 14
12 - 3/4 - 14
16 - 1 - 11
20 - 1-1/4 - 11
24 - 1-1/2 - 11

# METRIC ADAPTERS

## 9030M ...METRIC PLUG

9030-M08 x 1.0  
 9030-M10 x 1.0  
 9030-M10 x 1.5  
 9030-M12 x 1.0  
 9030-M12 x 1.5  
 9030-M14 x 1.5  
 9030-M16 x 1.5  
 9030-M18 x 1.5  
 9030-M20 x 1.5  
 9030-M22 x 1.5  
 9030-M24 x 1.5  
 9030-M26 x 1.5  
 9030-M30 x 1.5

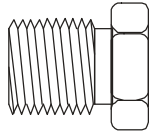

## 9029 ...HOLLOW HEX METRIC PLUG

9029-08 x 1.0  
 9029-10 x 1.0  
 9029-12 x 1.5  
 9029-14 x 1.5  
 9029-16 x 1.5  
 9029-18 x 1.5  
 9029-20 x 1.5  
 9029-22 x 1.5  
 9029-24 x 1.5  
 9029-26 x 1.5  
 9029-27 X 2.0  
 9029-33 X 2.0

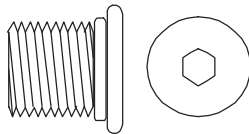

## 9235 ...METRIC to FEMALE PIPE

(1) (2)  
 9235-10-02  
 9235-12-04  
 9235-14-04  
 9235-16-06  
 9235-16-08  
 9235-18-08  
 9235-20-08  
 9235-22-06  
 9235-22-08  
 9235-26-08  
 9235-26-12

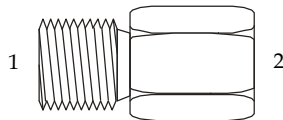

## 9200 ...JIC X METRIC STANDPIPE

(1) (2)  
 9200-04-06  
 9200-04-08  
 9200-04-10  
 9200-06-10  
 9200-08-10  
 9200-06-12  
 9200-08-12  
 9200-06-14  
 9200-08-15  
 9200-12-25

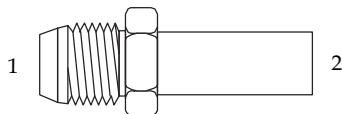

## 9022 ... JIC to METRIC SWIVEL

(1) (2)  
 9022-04-L06-12  
 9022-04-L08-14  
 9022-05-L06-12  
 9022-06-L08-14  
 9022-06-L10-16  
 9022-06-L12-18  
 9022-06-L15-22  
 9022-06-S12-20  
 9022-08-L10-16  
 9022-08-L12-18  
 9022-08-L15-22  
 9022-08-S12-20  
 9022-10-L12-18  
 9022-10-L15-22  
 9022-10-S12-20

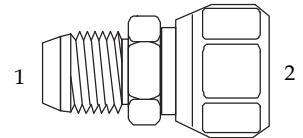

## 9068 ... JIC to MALE METRIC PORT

(1) (2)  
 9068-04-12  
 9068-04-14  
 9068-06-12  
 9068-06-14  
 9068-06-16  
 9068-06-18  
 9068-06-20  
 9068-06-22  
 9068-08-12  
 9068-08-14  
 9068-08-16  
 9068-08-18  
 9068-08-20  
 9068-08-22  
 9068-10-16  
 9068-10-18  
 9068-10-20  
 9068-10-22  
 9068-10-26  
 9068-12-26

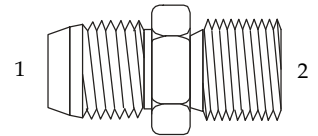

## 9069 ... JIC to METRIC 90°

(1) (2)  
 9069-04-10  
 9069-04-12  
 9069-04-14  
 9069-05-12  
 9069-05-14  
 9069-06-12  
 9069-06-14  
 9069-06-16  
 9069-06-18  
 9069-08-16  
 9069-08-18  
 9069-08-20  
 9069-08-22  
 9069-10-18  
 9069-10-20  
 9069-10-22  
 9069-12-22  
 9069-12-26  
 9069-12-27  
 9069-16-27  
 9069-16-33

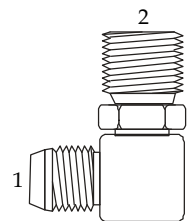

# METRIC & JAPANESE ADAPTERS

## 9201L ...METRIC TUBE NUT (LIGHT) DIN 2353 L

9201L-06  
9201L-08  
9201L-10  
9201L-12  
9201L-15  
9201L-18  
9201L-22  
9201L-28  
9201L-35  
9201L-42

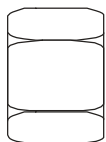

## 9202 ...METRIC TUBE CUTTING RING - DIN 2353 S/L

9202-06  
9202-08  
9202-10  
9202-12  
9202-14  
9202-15  
9202-16  
9202-18  
9202-20  
9202-22  
9202-25  
9202-28  
9202-30  
9202-35  
9202-38  
9202-42

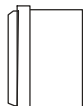

## 9201S ...METRIC TUBE NUT (HEAVY) DIN 2353 S

9201S-06  
9201S-08  
9201S-10  
9201S-12  
9201S-14  
9201S-16  
9201S-20  
9201S-25  
9201S-30  
9201S-38

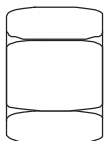

## 9232 ...JAPANESE KOMATSU CAP

9232-14 KOMATSU CAP (SOLID)  
9232-16 KOMATSU = 30° SEAT, 15mm PITCH,  
9232-18 METRIC THREAD  
9232-22  
9232-24  
9232-30  
9232-33  
9232-42

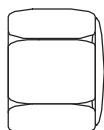

## 9231 ...JAPANESE KOMATSU METRIC PLUG

9231-14 KOMATSU HEX PLUG  
9231-16 KOMATSU = 30° SEAT, 1.5mm PITCH,  
9231-18 METRIC THREAD  
9231-22  
9231-24  
9231-30  
9231-33  
9231-36  
9231-42

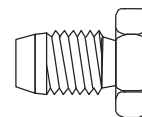

## 9236 ...MALE KOMATSU UNION

9236-14-14 MALE KOMATSU X MALE KOMATSU  
9236-18-18 KOMATSU = 30° SEAT, 1.5mm PITCH,  
9236-22-22 METRIC THREAD  
9236-24-24  
9236-30-30  
9236-33-33

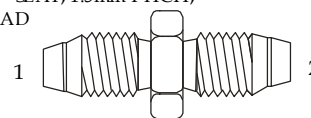

## 9237 ...MALE JIC x JAPANESE KOMATSU

(1) (2) MALE JIC X MALE KOMATSU  
9237-04-14 KOMATSU = 30° SEAT, 1.5mm PITCH,  
9237-06-16 METRIC THREAD  
9237-06-18  
9237-08-22  
9237-10-24  
9237-12-30  
9237-16-33

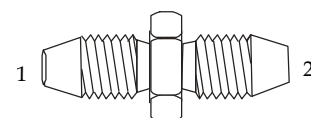

## 9222 ...JAPANESE 30° FLARE CAP

9222-02 JIS CAP (SOLID)  
9222-04 JIS = 30° SEAT, BSPP THREAD  
9222-06  
9222-08  
9222-10  
9222-12  
9222-16  
9222-20  
9222-24  
9222-32

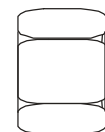

## 9221 ...JAPANESE 30° FLARE PLUG

9221-02 JIS HEX PLUG  
9221-04 JIS = 30° SEAT, BSPP THREAD  
9221-06  
9221-08  
9221-12  
9221-16  
9221-20  
9221-24  
9221-32

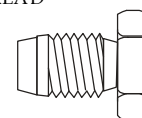

# LIVE SWIVEL JOINTS

## ...MALE JIC TO FEMALE JIC

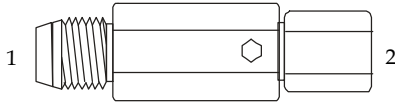

(1) (2)	Male JIC	Female JIC
S6-J6-JF6	9/16-18	9/16-18
S6-J8-JF8	3/4-16	3/4-16
S8-J10-JF10	7/8-14	7/8-14
S8-J12-JF12	1-1/16-12	1-1/16-12
S16-J16-JF16	1-5/16-12	1-5/16-12
S20-J20-JF20	1-5/8 -12	1-5/8 -12
S24-J24-JF24	1-7/8 -12	1-7/8 -12
S32-J32-JF32	2-1/2 -12	2-1/2 -12

## ...FEMALE PIPE UNION TO O-RING

(1) (2)  
 9S6PU4O6  
 9S6PU6O6  
 9S6PU6O8  
 9S8PU8O10  
 9S12PU12O12  
 9S16PU16O16  
 9S20PU20O20  
 9S24PU24O24  
 9S32PU32O32

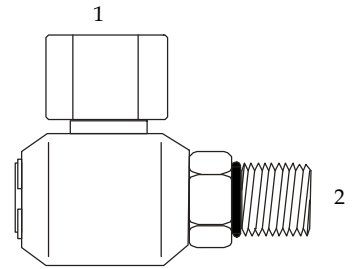

## ...FEMALE PIPE TO FEMALE PIPE

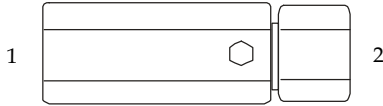

(1) (2)	FNPT	FNPT
S6PF4PF4	1/4 - 18	1/4 - 18
S6PF6PF6	3/8 - 18	3/8 - 18
S8PF8PF8	1/2 - 14	1/2 - 14
S8PF12PF12	3/4 - 14	3/4 - 14
S16PF16PF16	1 - 11-1/2	1 - 11-1/2
S20PF20PF20	1-1/4 - 11-1/2	1-1/4 - 11-1/2
S24PF24PF24	1-1/2 - 11-1/2	1-1/2 - 11-1/2
S32PF32PF32	2 - 11-1/2	2 - 11-1/2

## ...FEMALE PIPE UNION TO MALE PIPE

(1) (2)  
 9S6PU4P4  
 9S6PU4P6  
 9S6PU6P4  
 9S6PU6P6  
 9S8PU8P8  
 9S12PU12P12  
 9S16PU16P16  
 9S20PU20P20

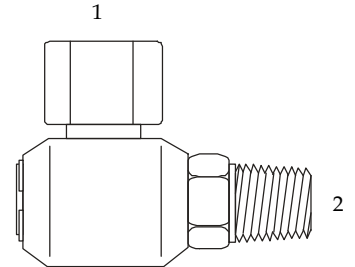

## ...MALE JIC TO FEMALE PIPE

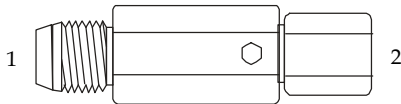

(1) (2)	Male JIC	FNPT
S6J6PF4	9/16-18	1/4 - 18
S6J8PF6	3/4-16	3/8 - 18
S8J10PF8	7/8-14	1/2 - 14
S8J12PF12	1-1/16-12	3/4 - 14
S16J16PF16	1-5/16-12	1 - 11-1/2
S20J20PF20	1-5/8 -12	1-1/4 - 11-1/2
S24J24PF24	1-7/8 -12	1-1/2 - 11-1/2
S32J32PF32	2-1/2 -12	2 - 11-1/2

## ...FEMALE PIPE UNION TO FEMALE PIPE

(1) (2)  
 9S6PU4PF4  
 9S6PU4PF6  
 9S6PU6PF4  
 9S6PU6PF6  
 9S8PU8PF8  
 9S12PU12PF12  
 9S16PU16PF16

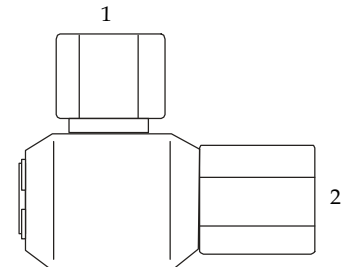

## ...FEMALE PIPE TO MALE PIPE

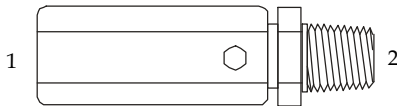

(1) (2)	FNPT	MNPT
S6PF4P4	1/4 - 18	1/4 - 18
S6PF6P6	3/8 - 18	3/8 - 18
S8PF8P8	1/2 - 14	1/2 - 14
S8PF12P12	3/4 - 14	3/4 - 14
S16PF16P16	1 - 11-1/2	1 - 11-1/2
S20PF20P20	1-1/4 - 11-1/2	1-1/4 - 11-1/2
S24PF24P24	1-1/2 - 11-1/2	1-1/2 - 11-1/2
S32PF32P32	2 - 11-1/2	2 - 11-1/2

## ...FEMALE PIPE TO FEMALE PIPE

(1) (2)  
 9S6PF4PF4  
 9S6PF4PF6  
 9S6PF6PF4  
 9S6PF6PF6  
 9S8PF8PF8  
 9S12PF12PF12  
 9S16PF16PF16  
 9S20PF20PF20  
 9S24PF24PF24  
 9S32PF32PF32

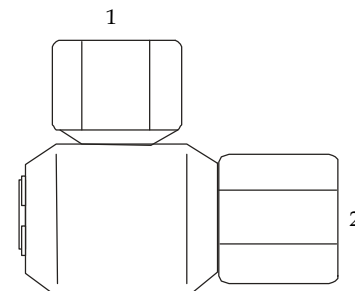

# LIVE SWIVEL JOINTS

## ...MALE JIC TO MALE O-RING

(1)(2)  
 9S6J6O6  
 9S6J6O8  
 9S6J8O8  
 S8J12O12  
 9S12J12O12  
 9S16J16O16  
 9S20J20O20

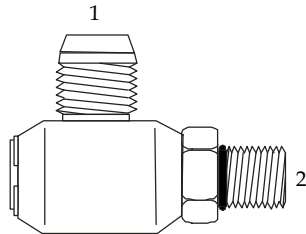

## ...MALE PIPE TO MALE O-RING

(1)(2)  
 9S6P4O5  
 9S6P4O6  
 9S6P6O5  
 9S6P6O6  
 9S6P6O8  
 9S8P8O10  
 9S12P12O12  
 9S16P16O16  
 9S20P20O20  
 9S24P24O24  
 9S32P32O32

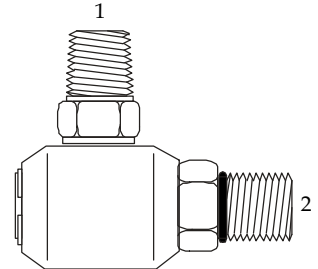

## ...MALE JIC TO MALE JIC

(1)(2)  
 9S6J5J5  
 9S6J5J6  
 9S6J6J5  
 9S6J6J6  
 9S6J6J8  
 9S6J8J8  
 9S8J10J10  
 9S12J12J12  
 9S16J16J16  
 9S20J20J20

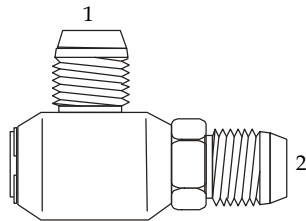

## ...MALE PIPE TO MALE PIPE

(1)(2)  
 9S6P4P4  
 9S6P4P6  
 9S6P6P4  
 9S6P6P6  
 9S8P8P8  
 9S12P12P12  
 9S16P16P16  
 9S20P20P20

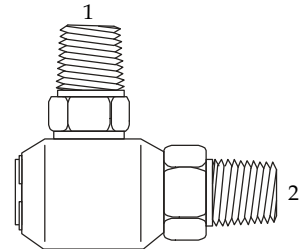

## ...MALE JIC TO MALE PIPE

(1)(2)  
 9S6J6P6  
 9S6J8P6  
 9S8J10P8  
 9S8J8P8  
 9S6J5P4  
 9S6J5P6  
 9S6J6P4  
 9S12J12P12  
 9S16J16P16  
 9S20J20P20

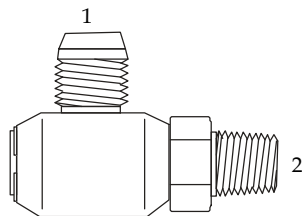

## ...MALE PIPE TO FEMALE PIPE

(1)(2)  
 9S6P4PF4  
 9S6P4PF6  
 9S6P6PF4  
 9S6P6PF6  
 9S8P8PF8  
 9S12P12PF12  
 9S20P20PF20  
 9S24P24PF24

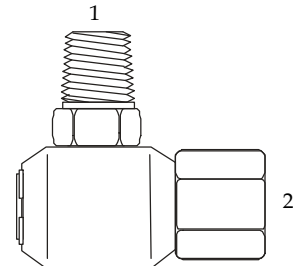

## ...MALE JIC TO FEMALE PIPE

(1)(2)  
 9S6J5PF4  
 9S6J5PF6  
 9S6J6PF4  
 9S6J6PF6  
 9S6J8PF6  
 9S8J10PF8  
 9S8J8PF8  
 9S12J12PF12  
 9S16J16PF16  
 9S20J20PF20

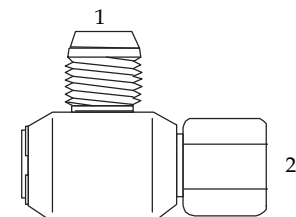

## S ...STRAIGHT SWIVEL REPAIR KIT

S6-1  
 S8-1  
 S12-1  
 S16-1  
 S20-1  
 S24-1  
 S32-1  
**Kit contains Dust and Fluid Seals with Retaining Rings, Balls, and Plugs as Applicable.**

## 9S ...90° SWIVEL REPAIR KIT

9S6-1  
 9S8-1  
 9S12-1  
 9S16-1  
 9S20-1  
 9S24-1  
 9S32-1  
**Kit contains Dust and Fluid Seals with Retaining Rings, Balls, and Plugs as Applicable.**

# SAE FLANGE ADAPTERS

## 6100 ...SAE CODE 61 FLANGE MALE JIC ADAPTER

- (1) (2)
- 6100-08-08
- 6100-08-12
- 6100-12-12
- 6100-12-16
- 6100-12-20
- 6100-16-12
- 6100-16-16
- 6100-16-10
- 6100-16-14
- 6100-20-16
- 6100-20-20
- 6100-20-24
- 6100-20-32
- 6100-24-20
- 6100-24-24
- 6100-24-32
- 6100-32-24
- 6100-32-32

"Some sizes available in Forged or Tube Style"

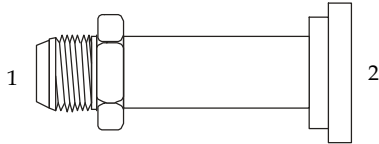

(1) Male Tube (2) C 61 Flange

## 6145 ...SAE CODE 61 FLANGE MALE JIC 45° ELBOW

- (1) (2)
- 6145-08-08
- 6145-08-12
- 6145-12-12
- 6145-12-16
- 6145-16-16
- 6145-16-20
- 6145-12-20
- 6145-16-20
- 6145-20-20
- 6145-16-24
- 6145-20-24
- 6145-24-24
- 6145-24-32
- 6145-32-32

"Some sizes available in Forged or Tube Style"

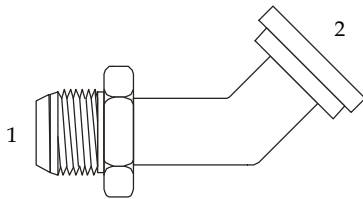

(1) Male Tube (2) C 61 Flange

## 6190 ...SAE C61 FLANGE MALE- JIC 90° ELBOW

- (1) (2)
- 6190-08-08
- 6190-12-12
- 6190-12-16
- 6190-12-20
- 6190-16-12
- 6190-16-16
- 6190-16-20
- 6190-16-24
- 6190-20-12
- 6190-20-16
- 6190-20-20
- 6190-20-24
- 6190-24-16
- 6190-24-20
- 6190-24-24
- 6190-24-32
- 6190-32-24
- 6190-32-32

"Some sizes available in Forged or Tube Style"

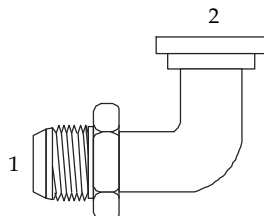

(1) Male Tube (2) C 61 Flange

## SFO ...SAE CODE 61 FLANGE KIT (3000 PSI)

- SFO-08
- SFO-12
- SFO-16
- SFO-20
- SFO-24
- SFO-32
- SFO-48
- SFO-56
- SFO-64

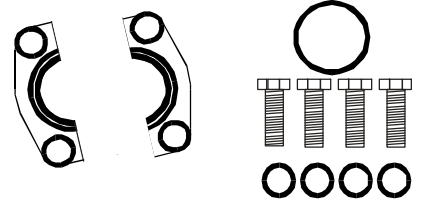

## FP ...SAE CODE 61 FLANGE PLUG

- FP-08
- FP-12
- FP-16
- FP-20
- FP-24
- FP-32



## W43 ...SAE CODE 61 FLANGE KIT (3000 PSI)

- W43-08-08U
- W43-12-12U
- W43-16-16U
- W43-20-20U
- W43-24-24U
- W43-32-32U
- W43-48-48U

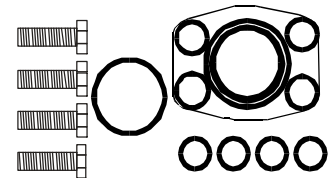

FLANGE SIZE	CODE 61 FLANGE DIA.	CODE 62 FLANGE DIA.
08 - 1/2"	08 - 1.188"	12 - 1.625"
12 - 3/4"	12 - 1.500"	16 - 1.875"
16 - 1"	16 - 1.750"	20 - 2.125"
20 - 1-1/4"	20 - 2.000"	24 - 2.500"
24 - 1-1/2"	24 - 2.375"	32 - 3.125"
32 - 2"	32 - 2.810"	
40 - 2-1/2"	40 - 3.312"	
48 - 3"	48 - 4.000"	

## SAE FLANGE O-RINGS

FLANGE SIZE	O-RING I.D.	WALL DIA.
PA-08	0.734"	0.139"
PA-12	0.984"	0.139"
PA-16	1.296"	0.139"
PA-20	1.484"	0.139"
PA-24	1.859"	0.139"
PA-32	2.234"	0.139"

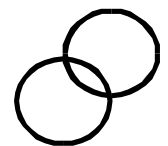

# SAE FLANGE ADAPTERS

## 6200 ...SAE CODE 62 FLANGE - MALE JIC ADAPTER

- (1) (2)  
 6200-08-08  
 6200-08-12  
 6200-12-12  
 6200-12-16  
 6200-12-20  
 6200-16-20  
 6200-16-24  
 6200-20-16  
 6200-20-20  
 6200-20-24  
 6200-20-32  
 6200-24-20  
 6200-24-24  
 6200-24-32  
 6200-32-24  
 6200-32-32

"Some sizes available in Forged or Tube Style"

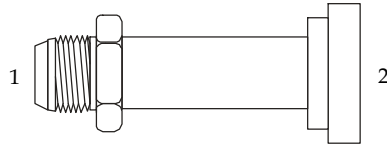

(1) Male Tube (2) C 62 Flange

## 6245 ...SAE CODE 62 FLANGE - MALE JIC 45°ELBOW

- (1) (2)  
 6245-08-08  
 6245-08-12  
 6245-12-12  
 6245-12-16  
 6245-16-16  
 6245-16-20  
 6245-12-20  
 6245-16-20  
 6245-16-24  
 6245-20-20  
 6245-20-24  
 6245-24-24  
 6245-24-32  
 6245-32-32

"Some sizes available in Forged or Tube Style"

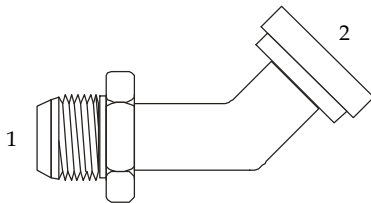

(1) Male Tube (2) C 62 Flange

## 6290 ...SAE CODE 62 FLANGE MALE JIC 90°ELBOW

- (1) (2)  
 6290-08-08  
 6290-12-12  
 6290-12-16  
 6290-12-20  
 6290-16-16  
 6290-16-20  
 6290-16-24  
 6290-20-12  
 6290-20-16  
 6290-20-20  
 6290-20-24  
 6290-24-16  
 6290-24-20  
 6290-24-24  
 6290-24-32  
 6290-32-24  
 6290-32-32

"Some sizes available in Forged or Tube Style"

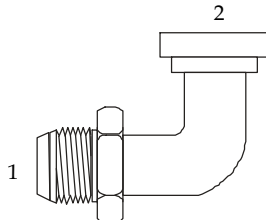

(1) Male Tube (2) C 62 Flange

## SFXO ...SAE CODE 62 FLANGE KIT (6000 PSI)

- SFXO-08  
 SFXO-12  
 SFXO-16  
 SFXO-20  
 SFXO-24  
 SFXO-32  
 SFXO-48  
 SFXO-56  
 SFXO-64

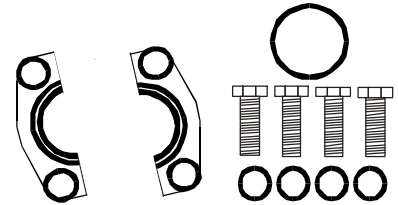

## FPX ...SAE CODE 62 FLANGE PLUG

- FPX-08  
 FPX-12  
 FPX-16  
 FPX-20  
 FPX-24  
 FPX-32



## W44 ...SAE CODE 62 FLANGE KIT (6000 PSI)

- W43-08-08U  
 W43-12-12U  
 W43-16-16U  
 W43-20-20U  
 W43-24-24U  
 W43-32-32U  
 W43-48-48U

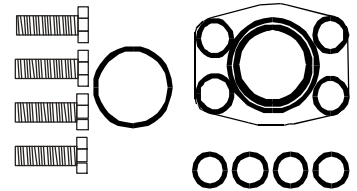

FLANGE SIZE	CODE 61 FLANGE DIA.	CODE 62 FLANGE DIA.
08 - 1/2"	08 - 1.188"	
12 - 3/4"	12 - 1.500"	12 - 1.625"
16 - 1"	16 - 1.750"	16 - 1.875"
20 - 1-1/4"	20 - 2.000"	20 - 2.125"
24 - 1-1/2"	24 - 2.375"	24 - 2.500"
32 - 2"	32 - 2.810"	32 - 3.125"
40 - 2-1/2"	40 - 3.312"	
48 - 3"	48 - 4.000"	

## SAE FLANGE O-RINGS

FLANGE SIZE	O-RING ID.	WALL DIA.
PA-08	0.734"	0.139"
PA-12	0.984"	0.139"
PA-16	1.296"	0.139"
PA-20	1.484"	0.139"
PA-24	1.859"	0.139"
PA-32	2.234"	0.139"

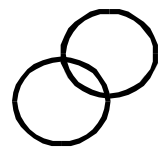



# BLACK PIPE FLANGE

# O-RINGS

## 1600 ... HOSE BARB X C61 FLANGE

- (1) (2)
- 1600-20-20
- 1600-20-24
- 1600-24-20
- 1600-24-24
- 1600-24-32
- 1600-32-24
- 1600-32-32
- 1600-32-40
- 1600-40-32
- 1600-40-40
- 1600-40-48
- 1600-48-40

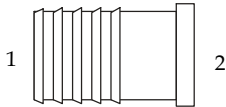

## 1600 ... HOSE BARB X C61 FLANGE 45° ELBOW

- (1) (2)
- 1645-20-20
- 1645-20-24
- 1645-24-20
- 1645-24-24
- 1645-24-32
- 1645-32-24
- 1645-32-32
- 1645-32-40
- 1645-40-32
- 1645-40-40
- 1645-40-48
- 1645-48-40

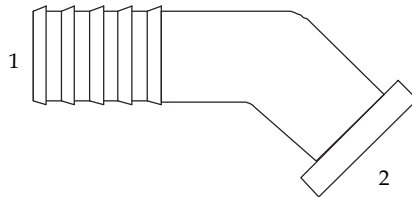

## 1600 ... HOSE BARB X C61 FLANGE 90° ELBOW

- (1) (2)
- 1690-20-20
- 1690-20-24
- 1690-24-20
- 1690-24-24
- 1690-24-32
- 1690-32-24
- 1690-32-32
- 1690-32-40
- 1690-40-32
- 1690-40-40
- 1690-40-48
- 1690-48-40
- 1690-48-48
- 1690-64-64

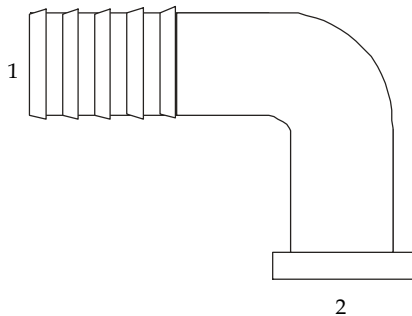

FLANGE SIZE	CODE 61 FLANGE DIAMETER
08 - 1/2"	08 - 1.188"
12 - 3/4"	12 - 1.500"
16 - 1"	16 - 1.750"
20 - 1-1/4"	20 - 2.000"
24 - 1-1/2"	24 - 2.375"
32 - 2"	32 - 2.810"
40 - 2-1/2"	40 - 3.312"
48 - 3"	48 - 4.000"

## SAE FLANGE O-RINGS

FLANGE SIZE	O-RING I.D.	WALL DIA.
PA-08	0.734"	0.139"
PA-12	0.984"	0.139"
PA-16	1.296"	0.139"
PA-20	1.484"	0.139"
PA-24	1.859"	0.139"
PA-32	2.234"	0.139"

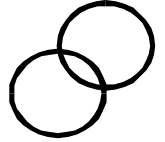

## ORB ... O-RING BOSS (ORB) O-RINGS

	O-RING I.D.	O-RING I.D.
ORB-2	.239"	ORB-12 .924"
ORB-3	.301"	ORB-14 .1.048"
ORB-4	.351"	ORB-16 .1.171"
ORB-5	.414"	ORB-20 .1.475"
ORB-6	.468"	ORB-24 .1.720"
ORB-8	.644"	ORB-32 .2.337"
ORB-10	.755"	

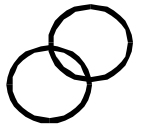

## ORS ... O-RING FACE SEAL (ORFS) O-RINGS

	O-RING I.D.	WALL I.D.
ORS-04	.301"	0.70
ORS-06	.364"	0.70
ORS-08	.489"	0.70
ORS-10	.614"	0.70
ORS-12	.739"	0.70
ORS-16	.926"	0.70
ORS-20	1.176"	0.70
ORS-24	1.489"	0.70



## 9500 ... BSPP BONDED SEALS

	BSPP THREAD
9500-02	1/8 - 27
9500-04	1/4 - 19
9500-06	3/8 - 19
9500-08	1/2 - 14
9500-10	5/8 - 14
9500-12	3/4 - 14
9500-16	1 - 11
9500-20	1-1/4 - 11
9500-24	1-1/2 - 11
9500-32	2 - 11

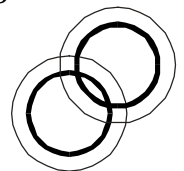

## 9500M ... METRIC BONDED SEALS

	METRIC THREAD
9500M-06	06mm
9500M-08	08mm
9500M-10	10mm
9500M-12	12mm
9500M-14	14mm
9500M-16	16mm
9500M-18	18mm
9500M-20	20mm
9500M-22	22mm
9500M-24	24mm
9500M-26	26mm
9500M-30	30mm
9500M-33	33mm

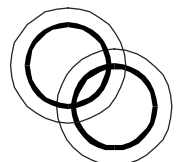



# **Hydraulic Hose & Fittings**



**Stirling Hydraulic**

**6807-68 Ave.  
Edmonton, AB.  
T6B 3E3**

**Ph: 780-450-6111  
Fax: 780-450-8887  
Email: [sales@stirlinghydraulic.com](mailto:sales@stirlinghydraulic.com)**

**Web Site: [www.stirlinghydraulic.com](http://www.stirlinghydraulic.com)**